

CEILING PANELS



www.project-inrichting.nl



info@witteveen.nl

www.scheidingswand.net

Baffle Ceiling Panels	4
Volumetric Ceiling Panels	10
Flat Ceiling Panels	20
Baffle Magnetic Ceiling Panels	32
Volumetric Magnetic Ceiling Panels	38
Flat Magnetic Ceiling Panels	44
Grid Frame	58
Color Swatches	66
Sustainability & Efficiency	70



BAFFLE CEILING PANELS

Baffle panels are a fantastic choice for spaces where you want to combine style and functionality.

Their repetitive design creates a rhythmic pattern that adds a contemporary and visually appealing touch to any room.

These panels are also highly effective at improving acoustics. They help to reduce noise levels by absorbing sound, making them perfect for environments where clear communication and comfort are key – like offices, restaurants, or even your home.

Features and benefits

- All panels are made from PET-Felt, known for its excellent acoustic properties.
- The panels are easy to install, designed to rest on a grid system.
- The Baffle Ceiling Panels Collection seamlessly blends with any interior design.

Applications

- Decorative and functional ceiling panel system for any interior spaces
- Grid ceiling can be customized with acoustic panels to enhance both its functionality and appearance.



SERPENS

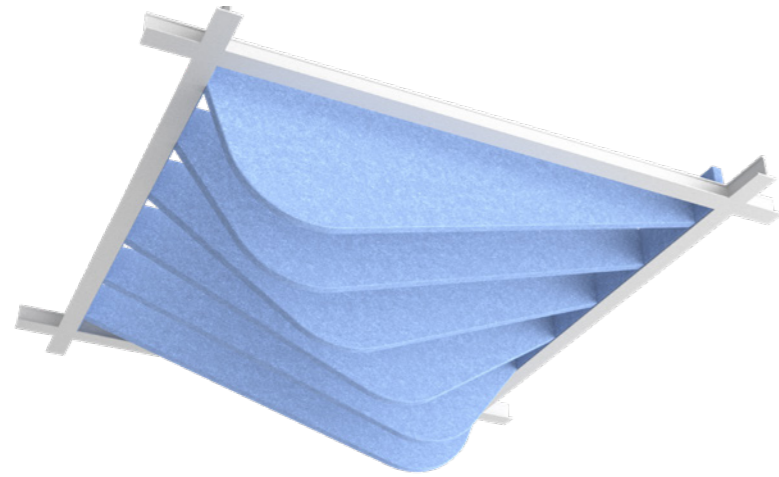

Serpens panels create the look of organic shapes, adding a unique touch to your grid ceiling and giving it a custom, stylish appearance.

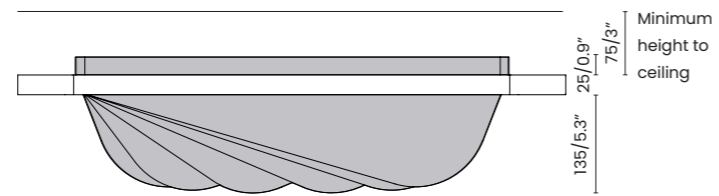

GLOBO

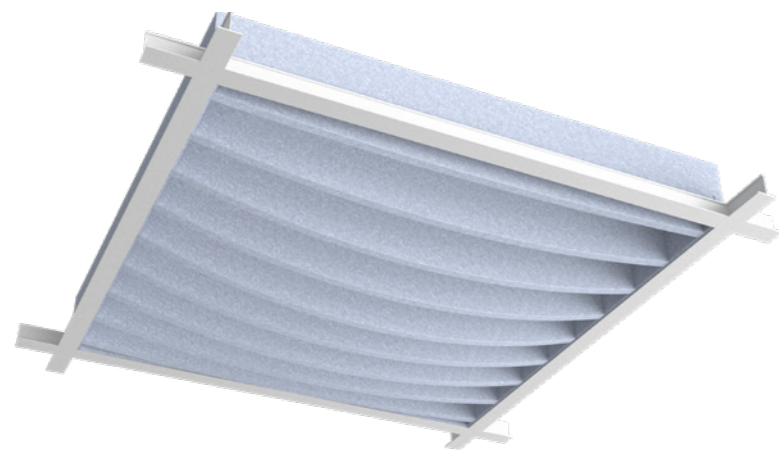

Just like their name implies, Globo ceiling panels bring a sense of depth to your ceiling with their elegant, curved shapes, creating a visually dynamic space.

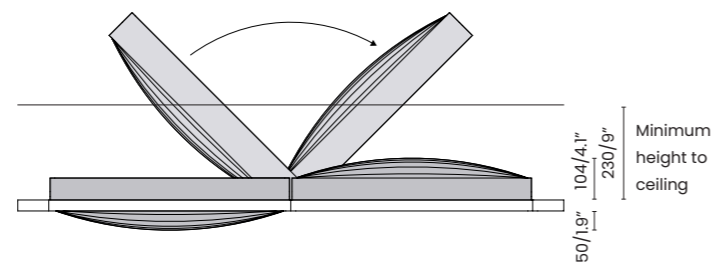

CALEUM 2

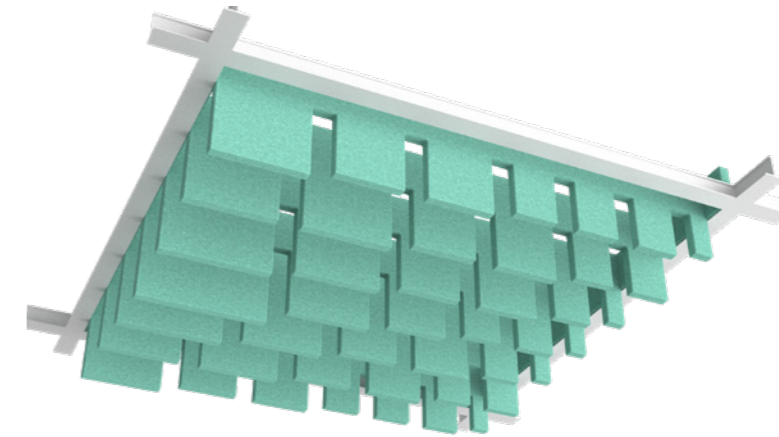

Inspired by geometric forms, Caleum panels not only offers an aesthetic solution but also generates favorable acoustics within a space.

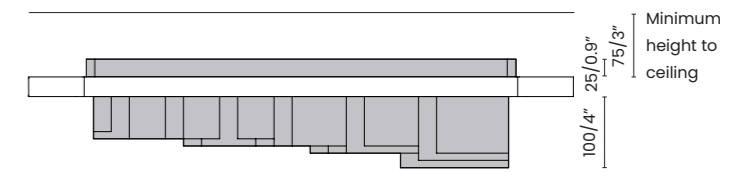

ALIS

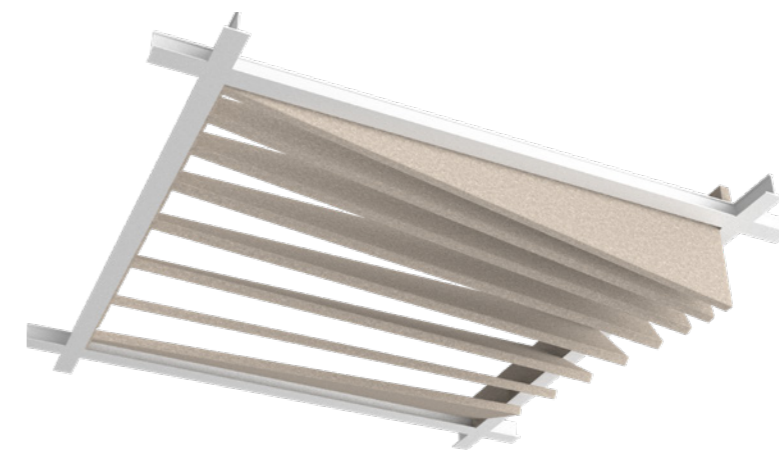

Alis acoustic solution offers a vibrant approach to ceiling panels. The way the panels are positioned enhances the acoustic performance of the space by diffusing sound.

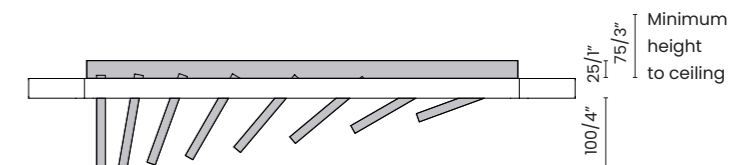





VOLUMETRIC CEILING PANELS

Volumetric Panels are a great option for spaces where you wish to reduce ceiling height and create an impressive visual impact.

This effect is achieved through the distinctive shapes formed by the bending of the material, which adds both depth and interest to the room.

Features and benefits

- All panels are made from PET-Felt, known for its excellent acoustic properties.
- The panels are easy to install, designed to rest on a grid system.
- The Volumetric Acoustic Ceiling Panels Collection seamlessly blends with any interior design.

Applications

- Volumetric aesthetic is a decorative and functional solution for any interior spaces
- Grid ceiling can be customized with acoustic panels to improve both its functionality and appearance, all without lowering its height.



PONS

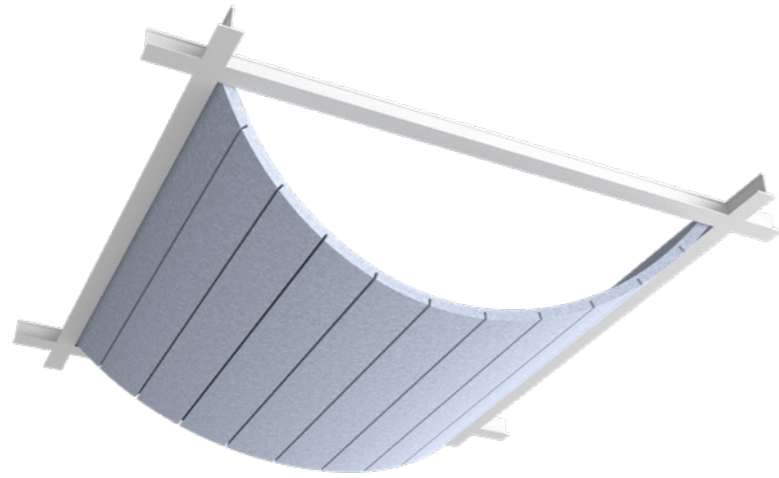

The engraved details of the Pons panels give them a concave shape, adding depth and elegance to the space.

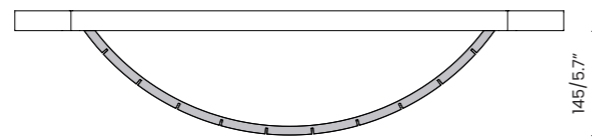

OBLIQUUM

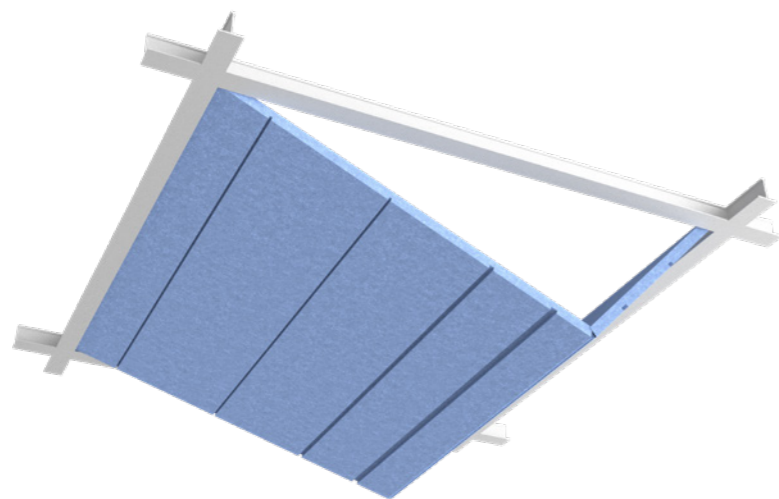

The dynamic design of the Obliquum panels adds an extra dimension to the interior environment, customizing the ceiling in a striking manner.

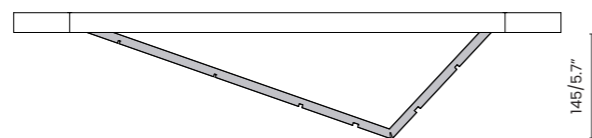

ANGOLO 2

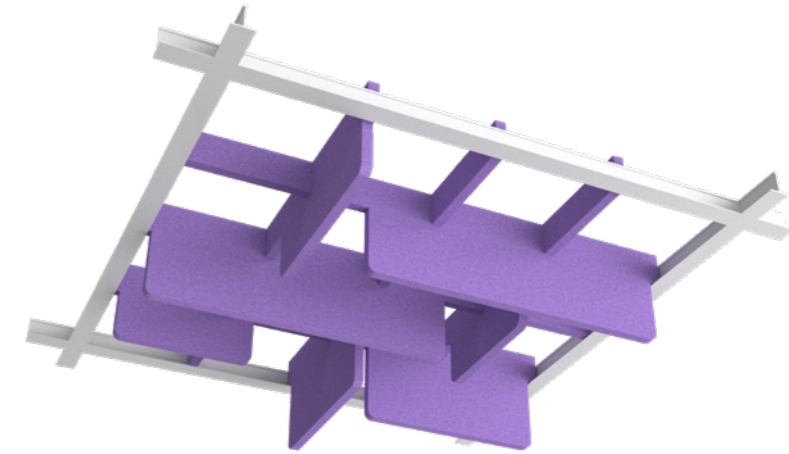

Angolo 2 distinguishes itself with a playful and bold design, including an open area above the panel that adds to its visual impact.

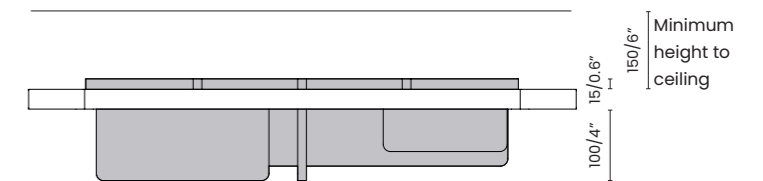

ANGOLO 3

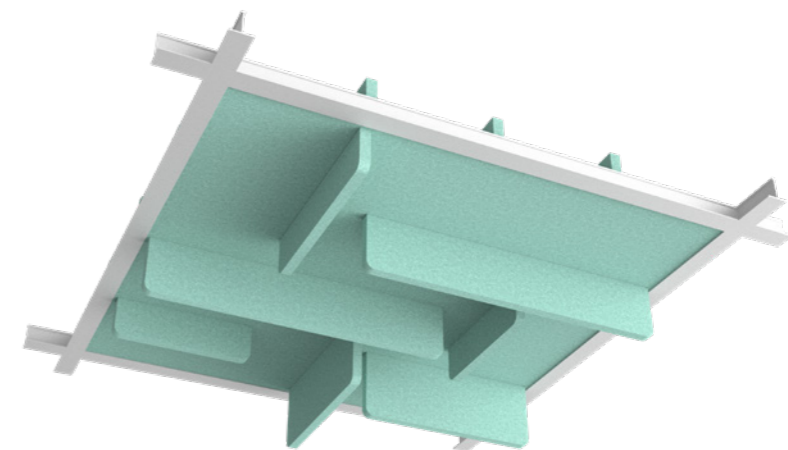

Angolo 3 features a vibrant and striking design, making it easy to integrate into any interior setting while adding a distinctive touch.

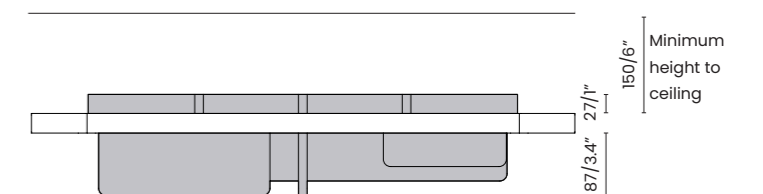



LUNA

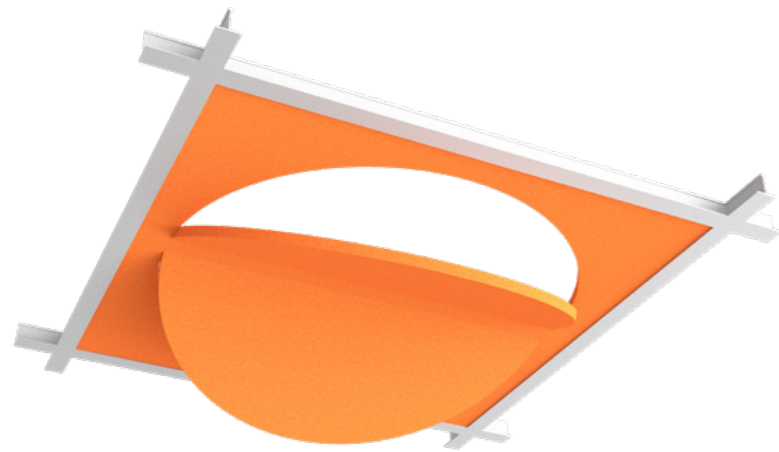

Due to its cut-out, the Luna panel adds a subtle and delicate touch to the space through its distinctive shapes, creating a play of light and shadow that enhances the ambiance and adds visual interest.

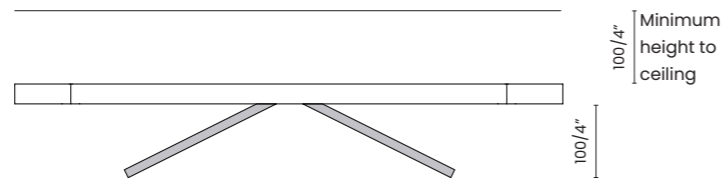

VENTO

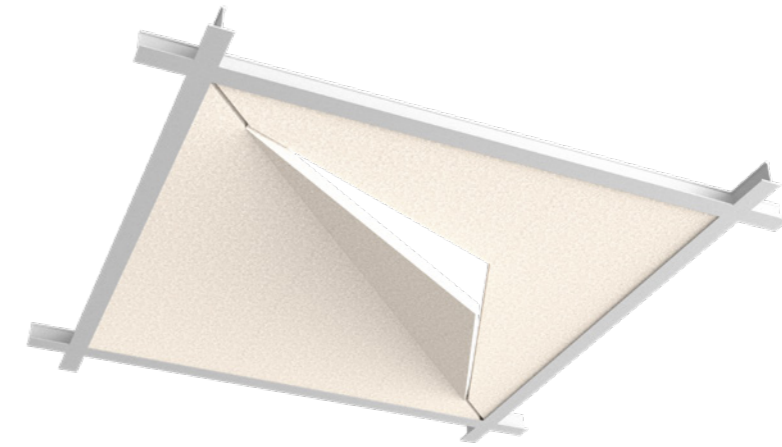

The Vento panel features well-defined, simple yet provocative lines due to its volumetric character. The resulting compositions with this model are dynamic, a quality further enhanced by the panels' magnetic attachment system.

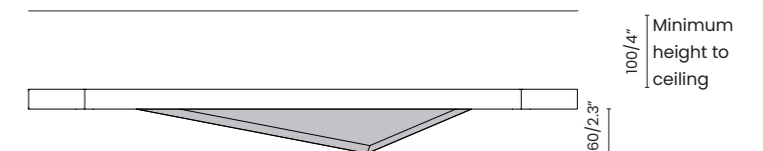

PYRAMIS

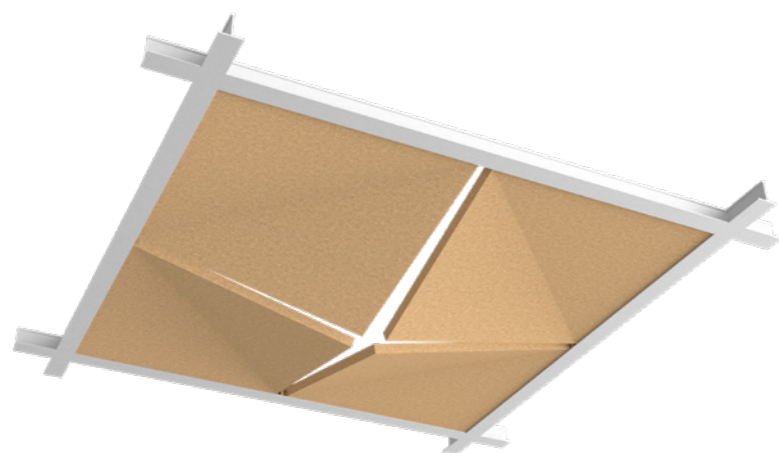

As the name suggests, the shape of the Pyramis panels resembles the volume of a pyramid. This configuration captures the interplay between light and shadow.

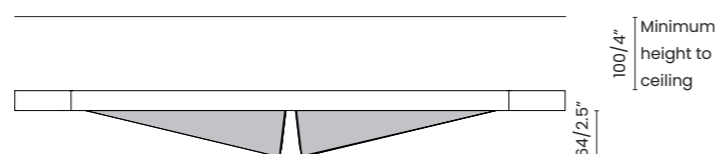

INTUS

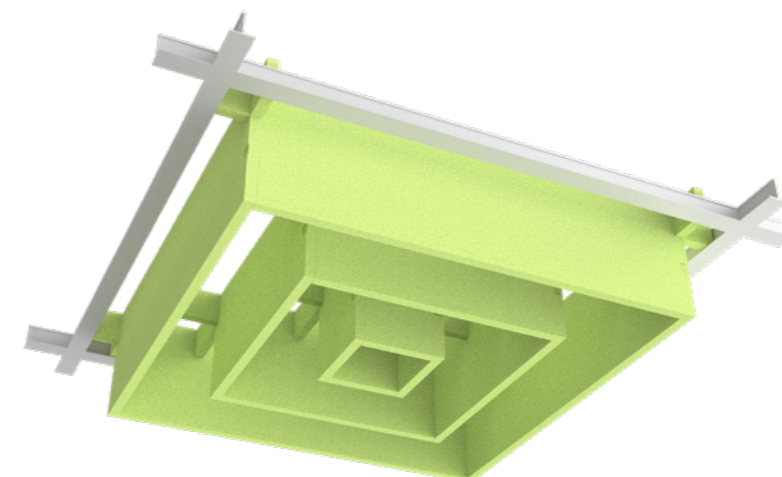

The repetitive rectangular composition of the Intus panel not only conveys depth and rhythm, but also enhances the overall aesthetic of the ceiling.

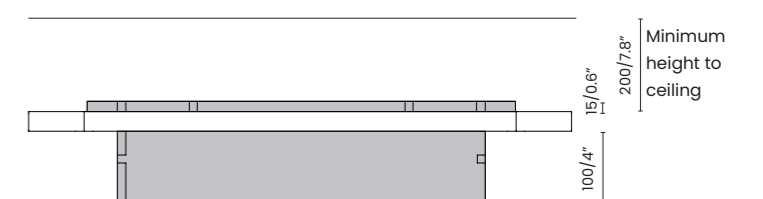



TECTUM

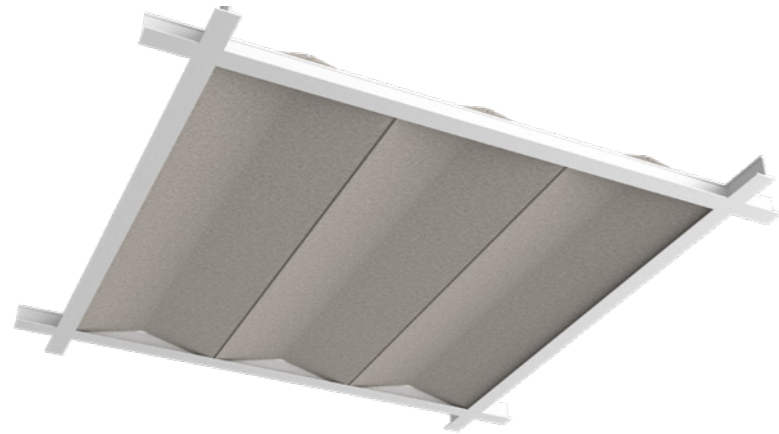

The folding form of the Tectum panel aids in sound absorption and diffusion within the room. In addition to its acoustic properties, Tectum is an excellent solution for adding rhythm and dimension to the space where it is installed.

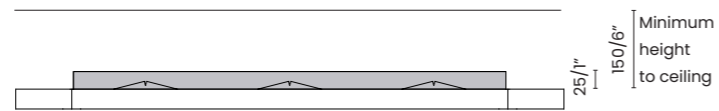

MONS

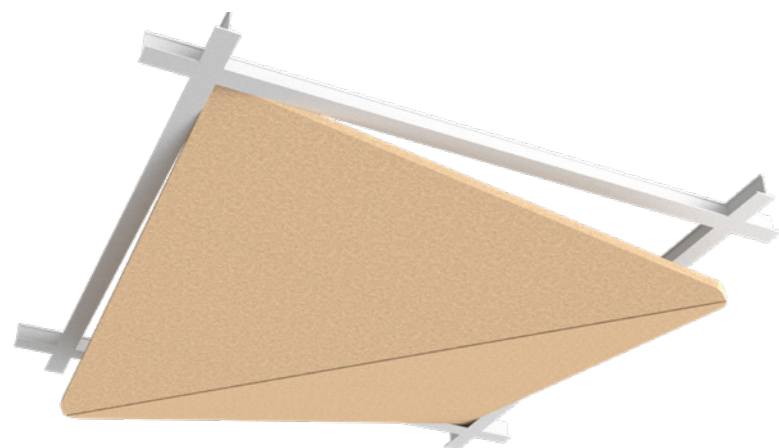

The Mons acoustic panels provide a sense of volume through their diagonal folds, offering a peaceful and easily integrated dimensionality that suits any interior space.

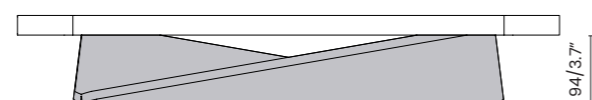

PARALLELA

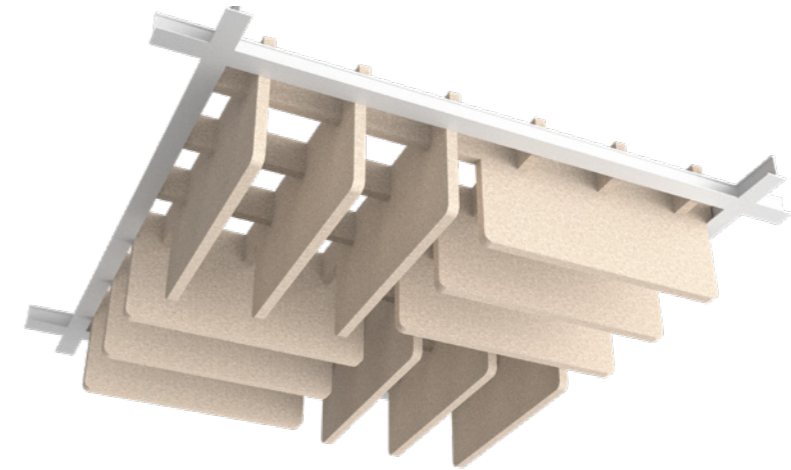

The Parellela acoustic solution is notable for its minimalist and repetitive geometry, which not only introduces a striking rhythm to the space but also amplifies both the visual appeal and the acoustic quality.

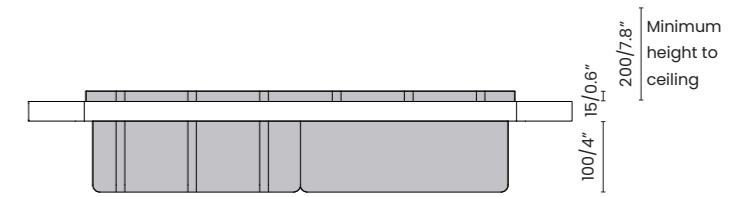

CALEUM 3

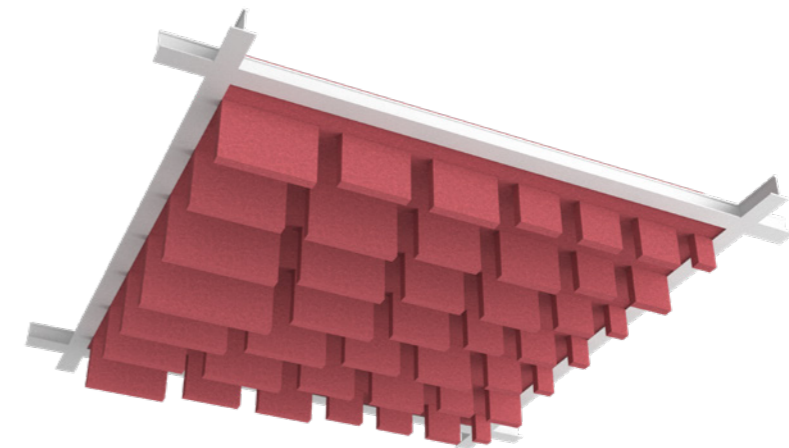

The Caleum 3 panel boasts a fun and eye-catching shape. Its elaborate design adds a dynamic and lively atmosphere to any space, thanks to the fascinating forms and shadows it creates.

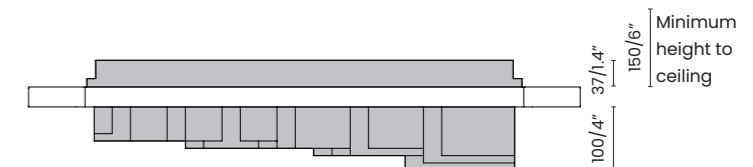





FLAT CEILING PANELS

The sleek design of the Flat Panels not only elevates the visual appeal of the ceiling but also maintains the room's height, making them a perfect choice for areas with low ceilings.

Their streamlined look fits beautifully with modern interiors, while also improving both the space's visual charm and its sound quality.

Features and benefits

- All panels are made from PET-Felt, known for its excellent acoustic properties.
- The panels are easy to install, designed to rest on a grid system.
- The Flat Acoustic Ceiling Panels Collection seamlessly blends with any interior design.

Applications

- Flat panels are available in a variety of designs and styles, offering options to suit any space.
- Grid ceiling can be customized with acoustic panels to improve both its functionality and appearance, all without lowering its height.

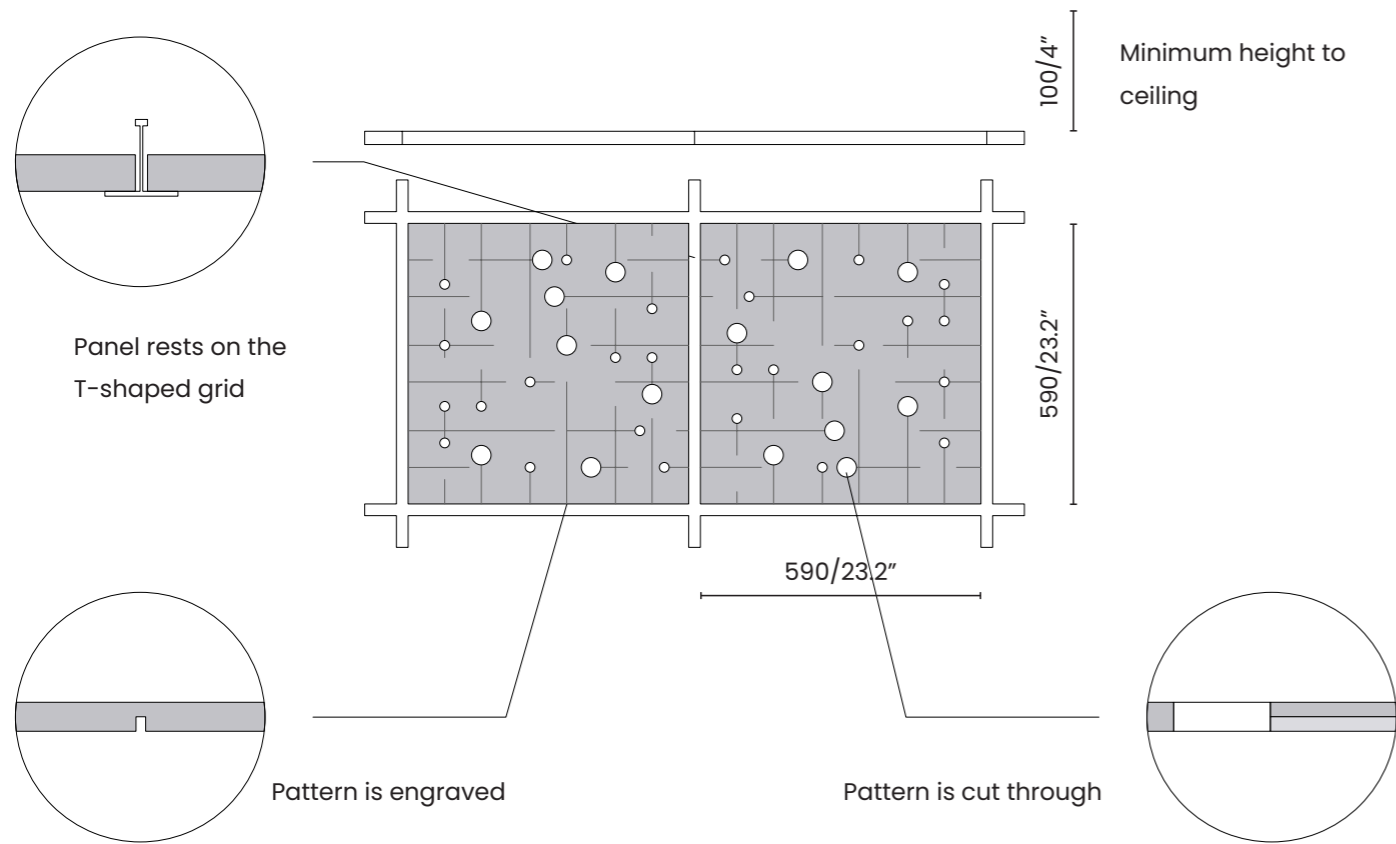

VIA

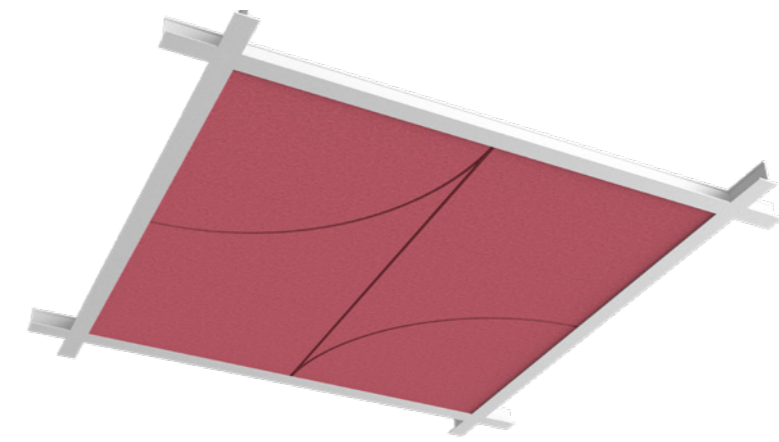

The Via panel features engraved curved lines that form a minimalist and refined pattern. This design not only enhances visual appeal, but also delivers enduring acoustic performance.

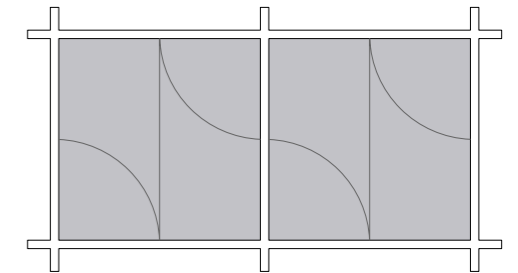

FAVO

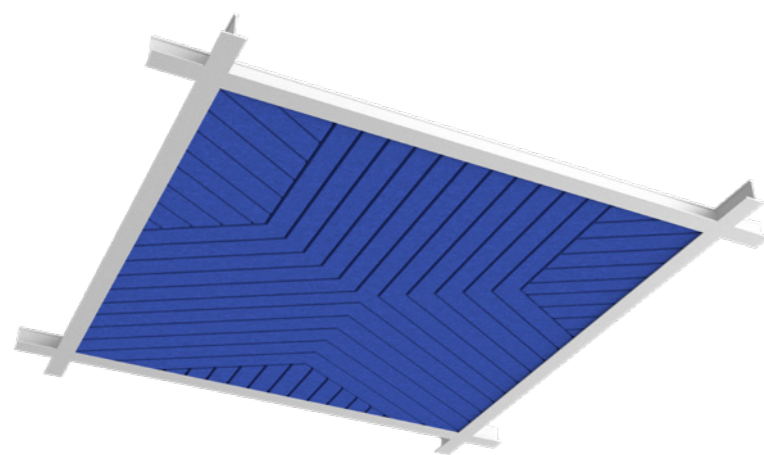

Favo is an acoustic solution featuring a seamless design that showcases a repetitive, yet elegant rhythm. Its unique aesthetic and sound-absorbing qualities make it an ideal choice for enhancing the ambiance of various interior spaces.

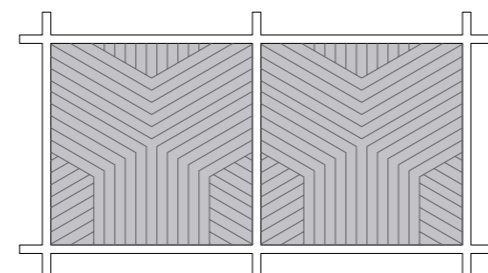

INTERSECTIO

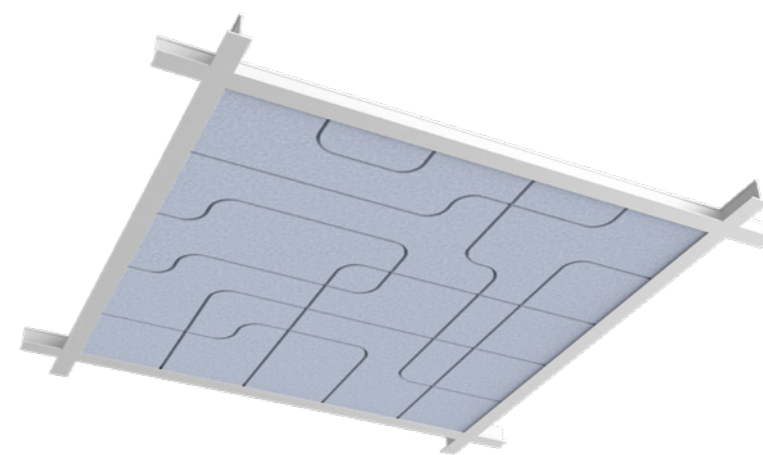

Intersectio stands out with its overlapping lines that create a seamless, playful, and captivating design, while also delivering excellent acoustic performance for any indoor environment.

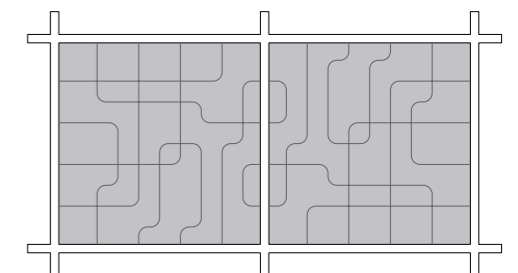



IRIS

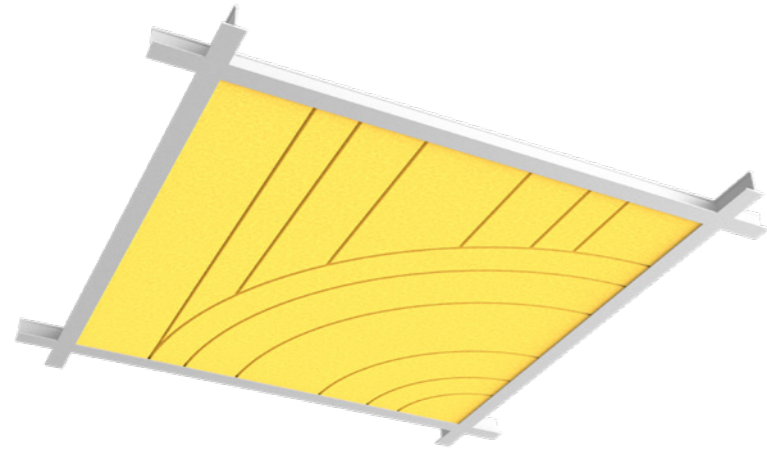

The Iris panel's design beautifully blends curved and straight lines, creating a range of vibrant and eye-catching patterns. offers both appeal and adaptability, making it ideal for various spaces.

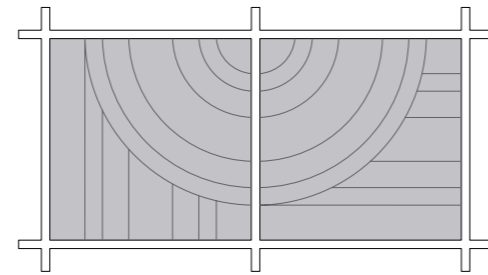

ARCO 2

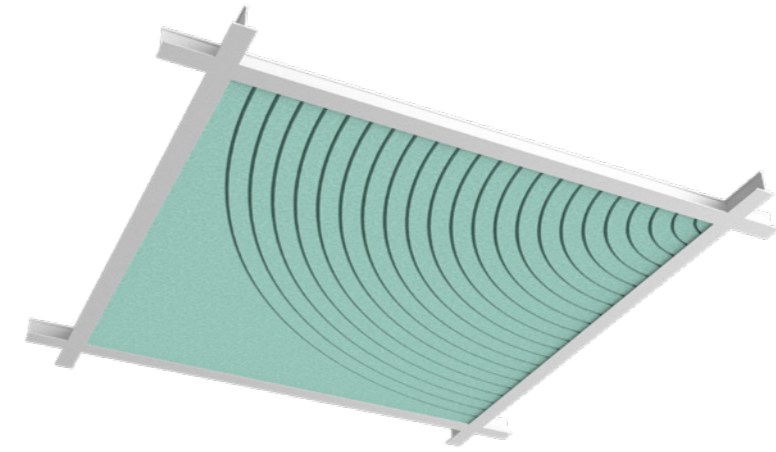

The Arco 2 acoustic ceiling panel features a series of engraved arcs on its visible surface, allowing for the creation of multiple wavy patterns.

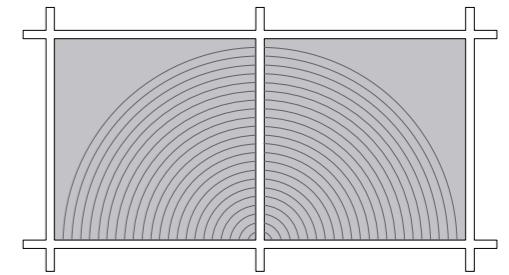

ARCO 1

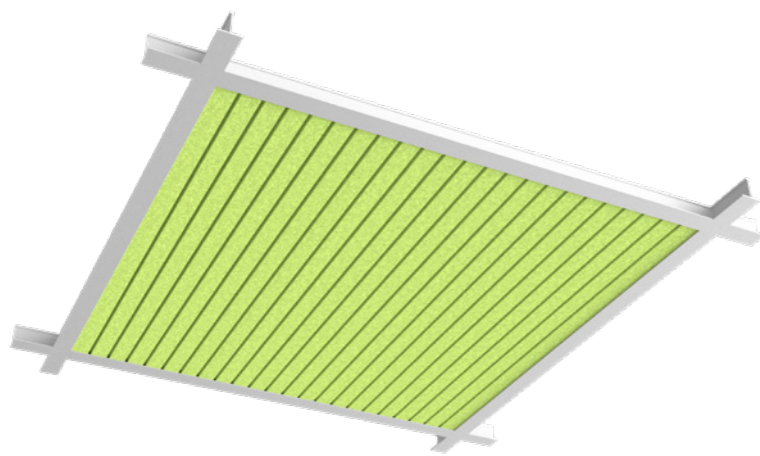

The repeated engraved lines on the Arco 1 panel create a calm and stable pattern, providing an acoustic solution that adds depth and elegance to the room.

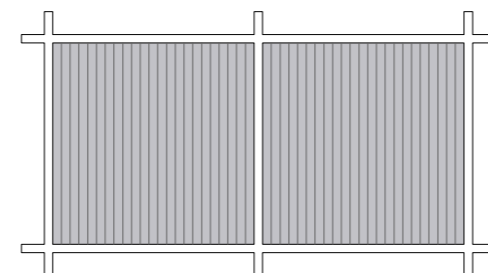

ARCO 3

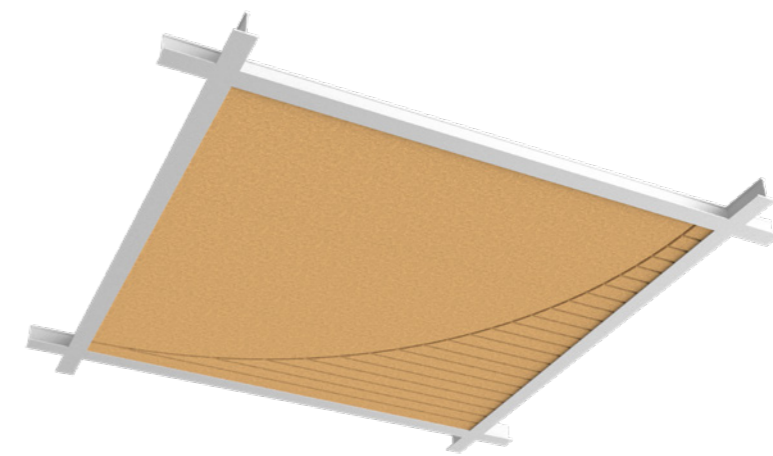

Arco 3 draws inspiration from the design of the Arco 1 and Arco 2 panels, maintaining the aesthetic direction of repeated lines to create a versatile and rhythmic design.

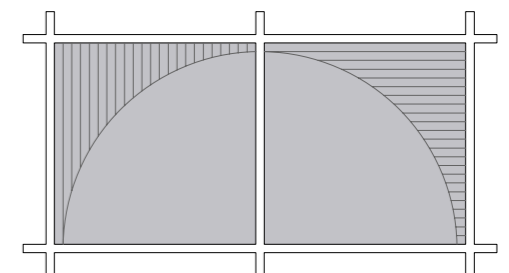



SOPRA 1

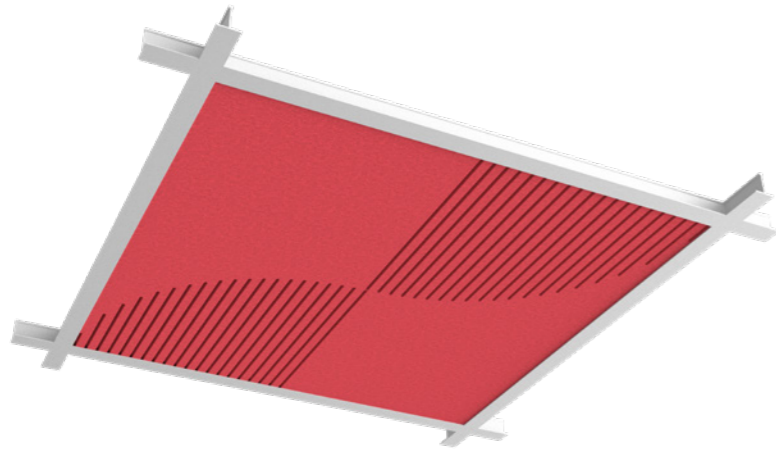

The simple, yet elegant arrangement of Sopra 1 provides a clean, modern look while enhancing acoustic performance.

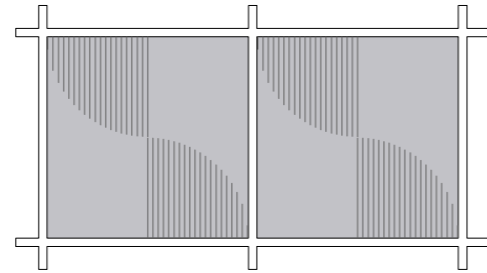

SOPRA 3

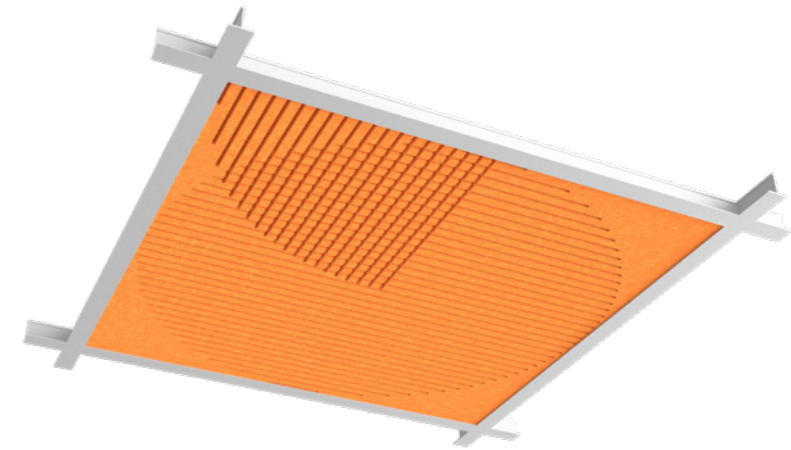

The combination of the patterns from the Sopra 1 and Sopra 2 panels creates a third design in the Sopra collection. This new model features a more elaborate and detailed pattern, providing a visually striking look

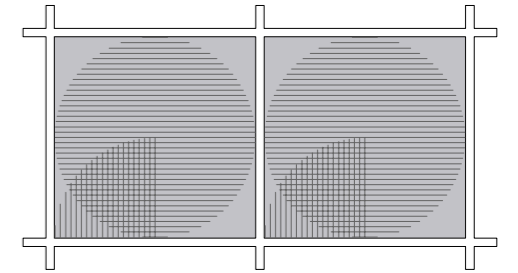

SOPRA 2

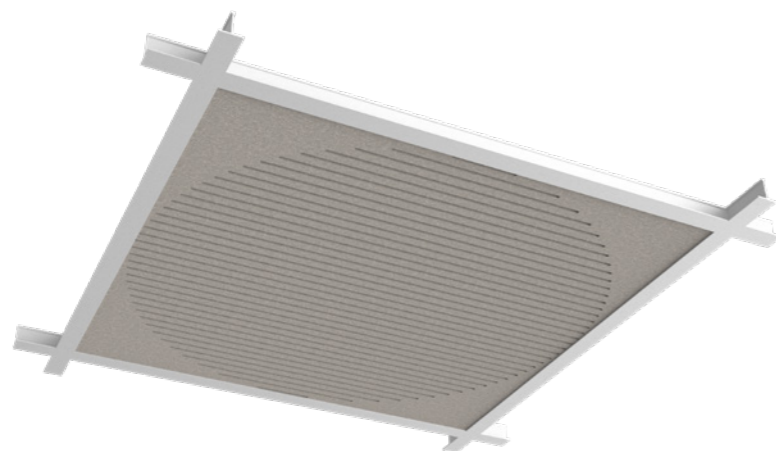

The Sopra 2 ceiling acoustic panel reimagines the Sopra 1 design by featuring engraved lines that form a circle, introducing a circular element to balance the formal rectangular grid.

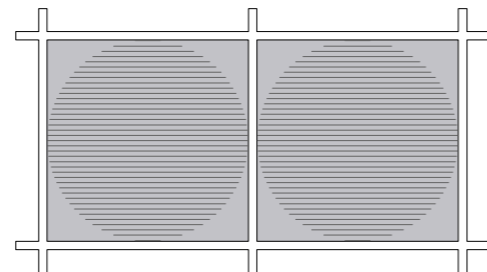

ILLUSIO 1

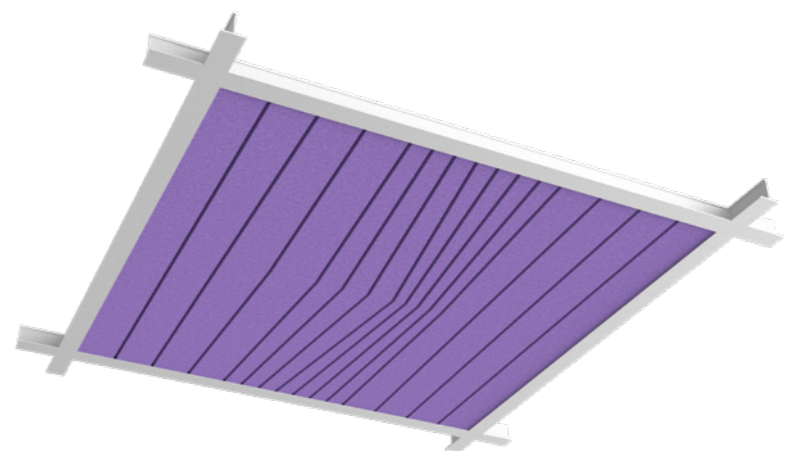

Illusio 1 is an acoustic ceiling panel distinguished by its visually appealing approach, featuring the concept of optical illusion.

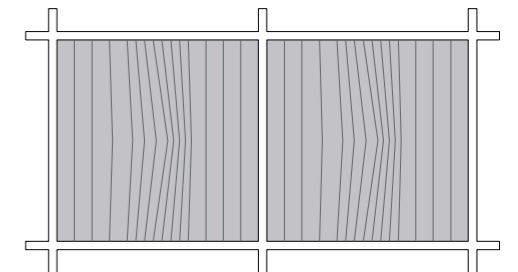



ILLUSIO 2

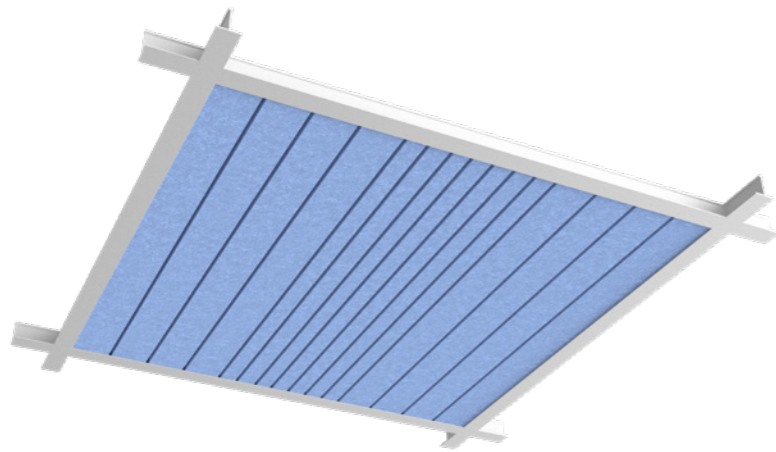

The Illusio 2 panel showcases a subtle aesthetic. It retains the stylistic concept of optical illusions, utilizing straight lines to achieve a more subtle and understated visual impact.

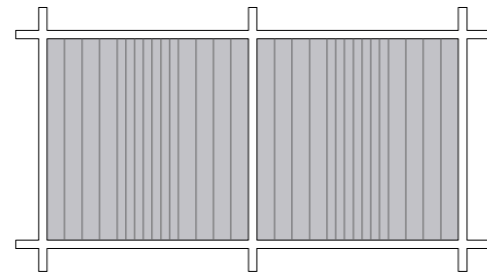

DULCIS

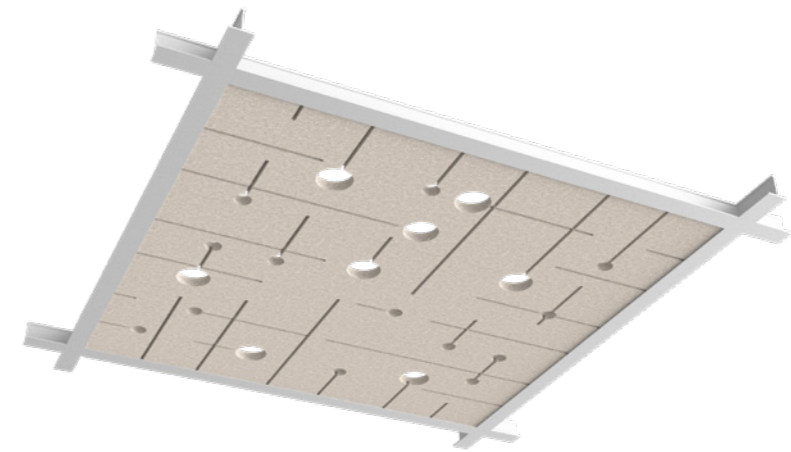

Dulcis makes a notable visual impression with its vibrant, engaging, and bold design. It provides outstanding acoustic performance, combining visual excitement with practical functionality.

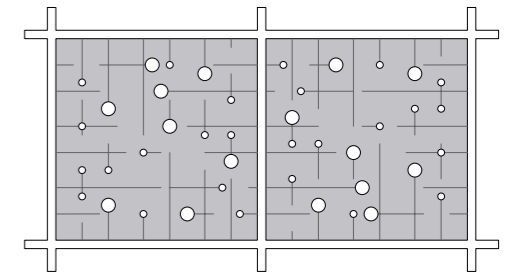

RETE

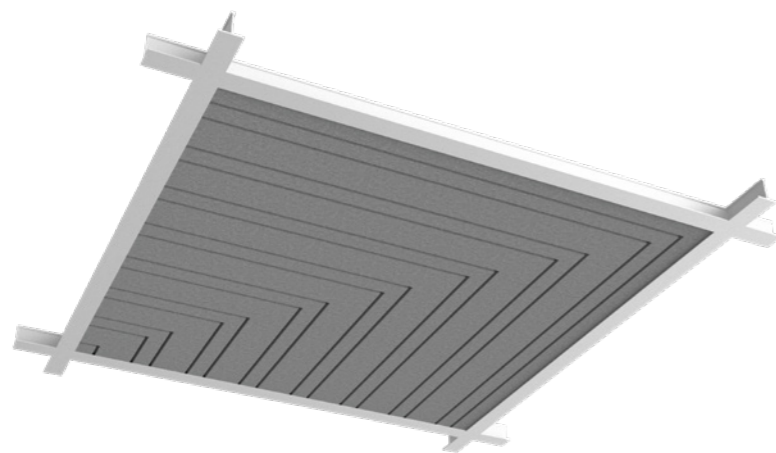

The Rete acoustic ceiling panel is distinguished by its engraved rectangular lines, which add a classic touch to the overall pattern created on the ceiling using these panels.

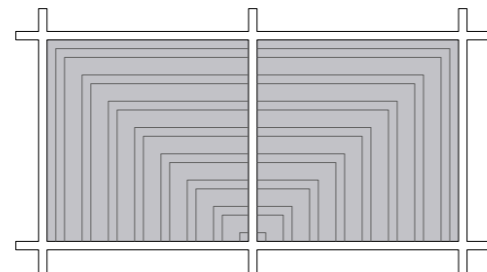

DISPERGO

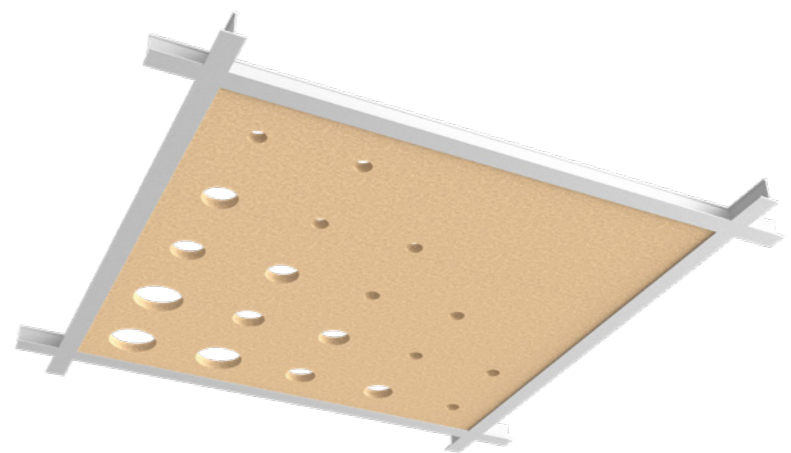

Featuring a subtle and friendly design, the Dispergo acoustic panel can be seamlessly incorporated into a wide range of environments.

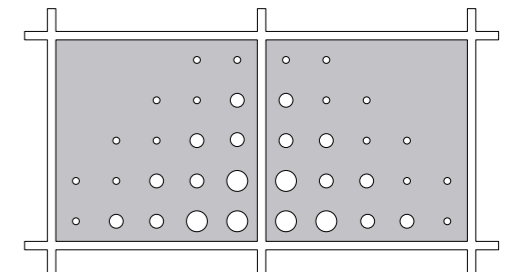



ANGOLO 1

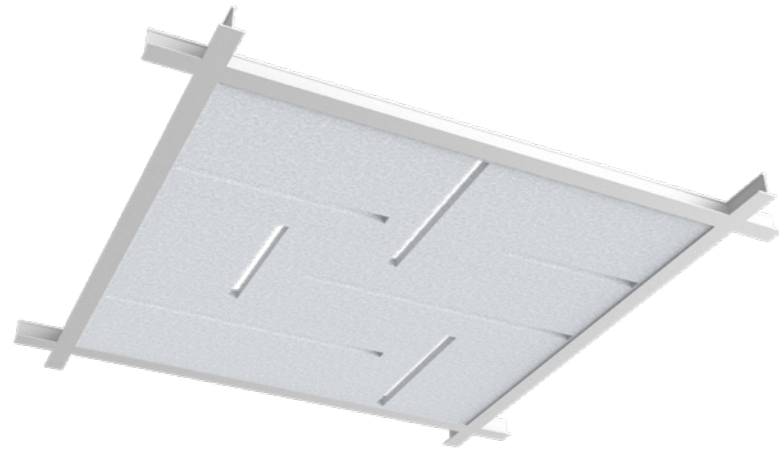

The cut-outs of the Angolo 1 acoustic pane create a precise and elaborate geometry, from which results a notably refined pattern.

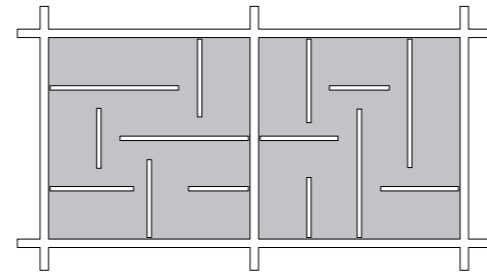

TRANSVERSUS

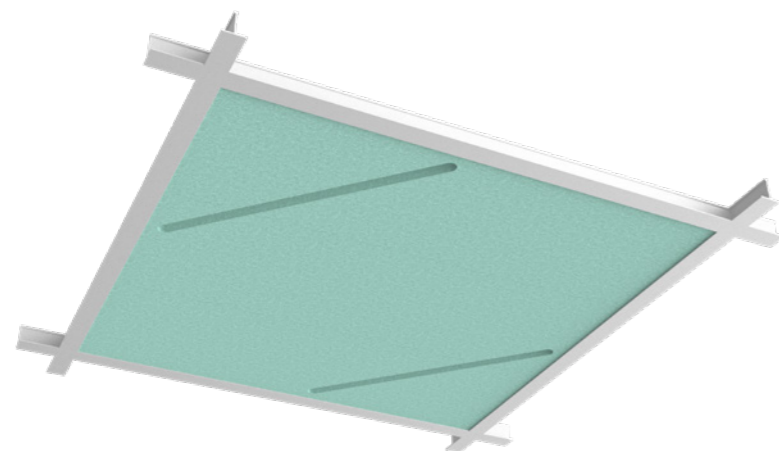

In addition to its acoustic properties, the Transversus panel is distinguished by its minimalist design with a range of possibilities for creating striking patterns on the ceiling.

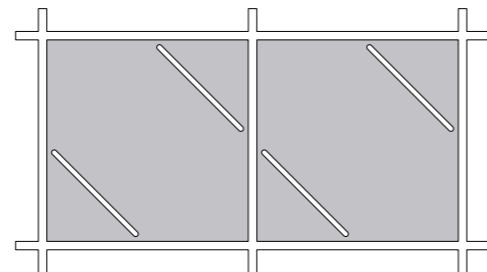

SECARE

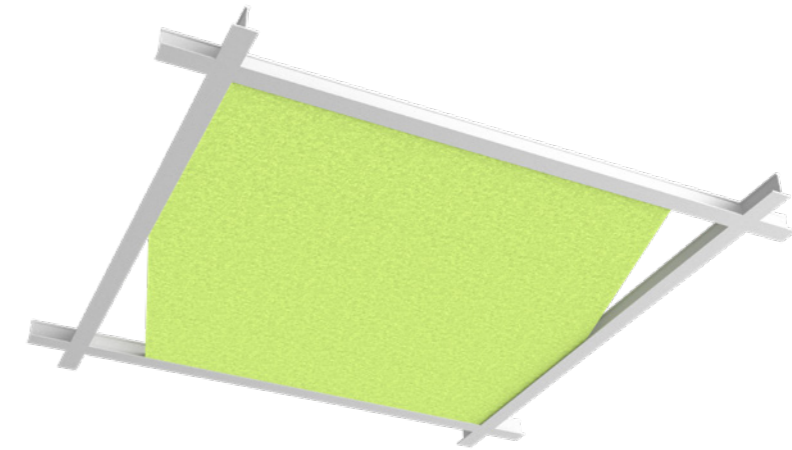

Secare is perfect for improving both the acoustic performance and the aesthetic appeal of a space. Crafted in a minimalist style, Secare offers an elegant solution with a variety of compositional options.

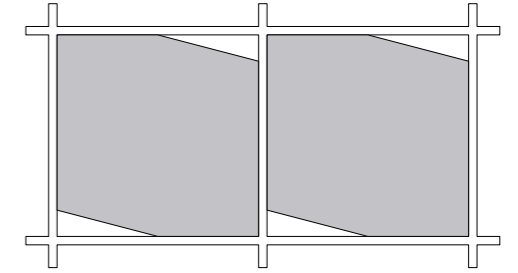

CALEUM 1

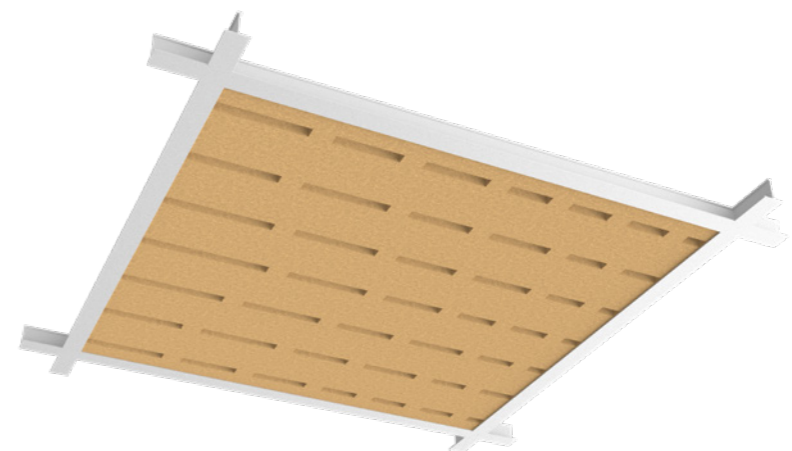

The Caleum 1 acoustic panel stands out with its distinct, calm, and sequential aesthetic rhythm, creating a distinctive ambiance in any space where it is installed.

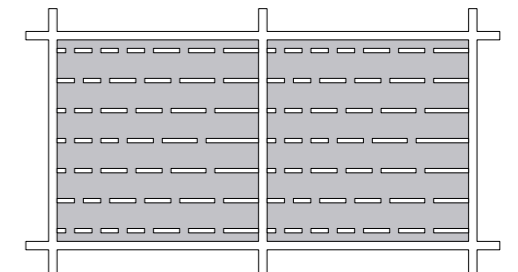



MAGNETIC BAFFLE CEILING PANELS

The Magnetic Baffle Panels form a rhythmic pattern with their repetitive arrangement, offering an easy installation process.

The Magnetic Baffle Ceiling Panels Collection, crafted from PET-Felt, provides a simple solution with outstanding sound absorption to improve acoustic quality. Its magnetic design ensures easy installation and flexibility.

Features and benefits

- All panels are made from PET-Felt, known for its excellent acoustic properties.
- The magnetic panels provide an easy installation process.
- The Baffle Ceiling Panels Collection seamlessly blends with any interior design.

Applications

- Decorative and functional ceiling panel system for any interior spaces.
- Grid ceiling can be customized with acoustic panels to enhance both its functionality and appearance.



SERPENS

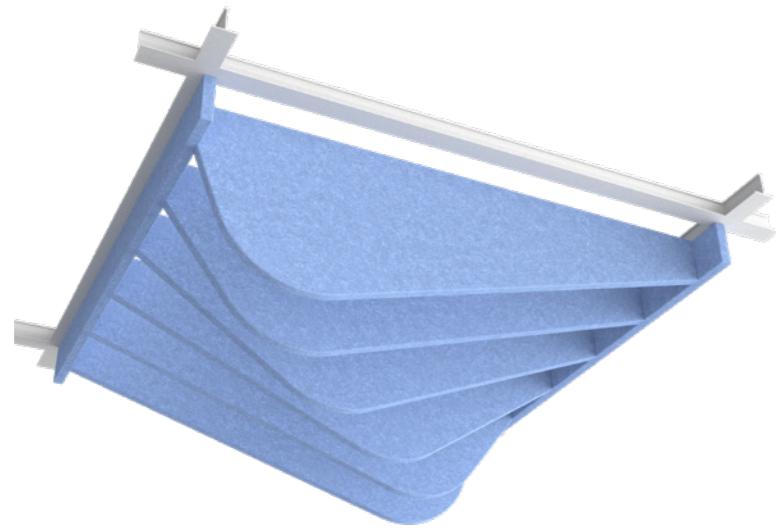

Serpens panels create the look of organic shapes, adding a unique touch to your grid ceiling and giving it a custom, stylish appearance.

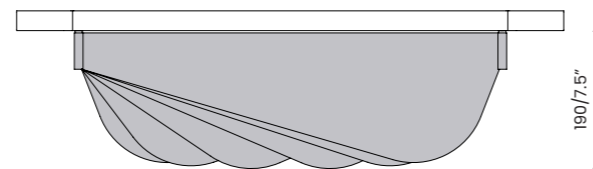

CALEUM 2

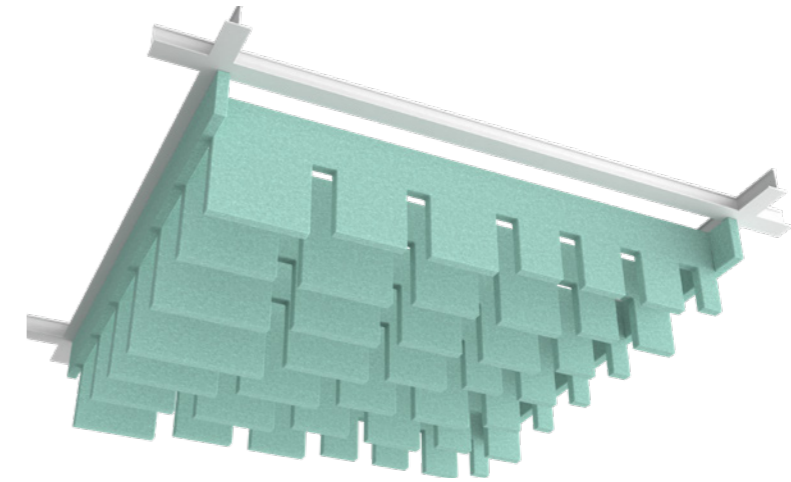

Inspired by geometric forms, Caleum panels not only offers an aesthetic solution but also generates favorable acoustics within a space.

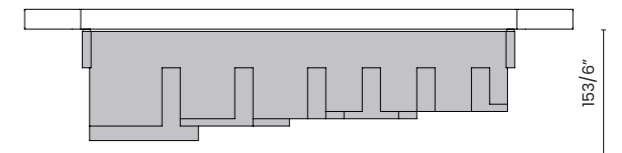

GLOBO

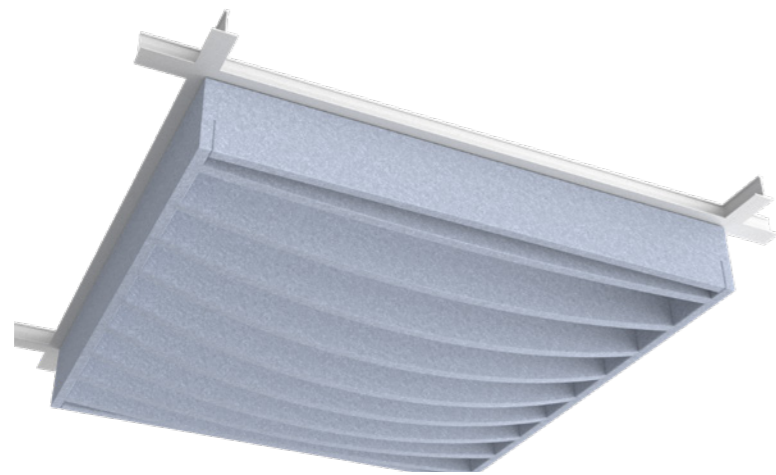

Just like their name implies, Globo ceiling panels bring a sense of depth to your ceiling with their elegant, curved shapes, creating a visually dynamic space.

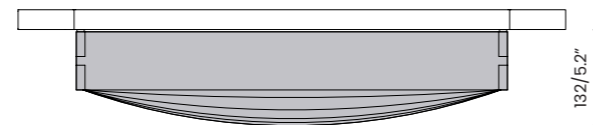





MAGNETIC VOLUMETRIC CEILING PANELS

Featuring quick and easy installation, the volumetric magnetic panels are an excellent choice for spaces where you want to lower the ceiling height and add visual emphasis.

This is accomplished through the unique shapes created by the material's bending. The Magnetic Acoustic Ceiling Panels Collection, made out of PET-Felt, is a non-invasive solution that delivers exceptional sound absorption for improved acoustics.

Features and benefits

- All panels are made from PET-Felt, known for its excellent acoustic properties.
- The magnetic panels provide an easy installation process.
- The Volumetric Acoustic Ceiling Panels Collection seamlessly blends with any interior design.

Applications

- Volumetric aesthetic is a decorative and functional solution for any interior spaces
- Grid ceiling can be customized with acoustic panels to improve both its functionality and appearance, all without lowering its height.



ANGOLO 2

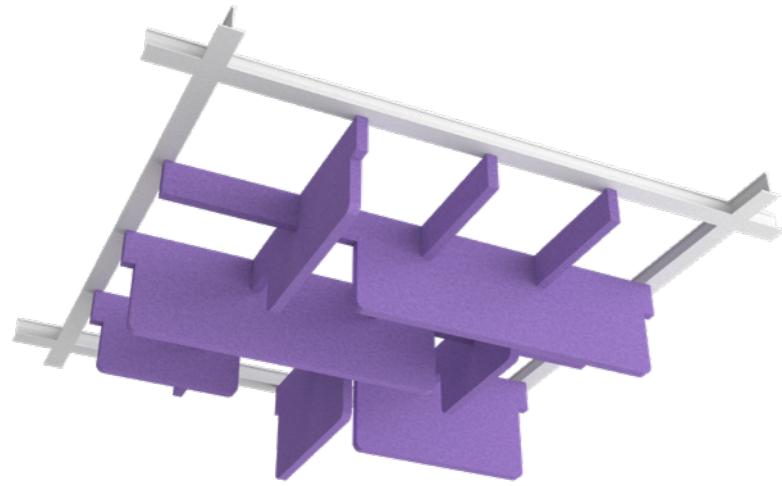

Angolo 2 distinguishes itself with a playful and bold design, including an open area above the panel that adds to its visual impact.

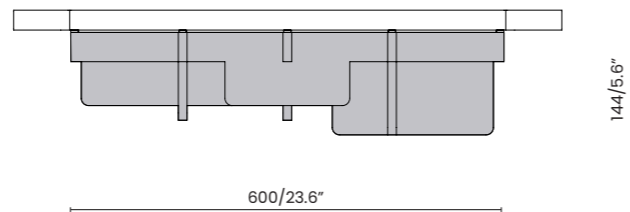

LUNA



Due to its cut-out, the Luna panel adds a subtle and delicate touch to the space through its distinctive shapes, creating a play of light and shadow that enhances the ambiance and adds visual interest.

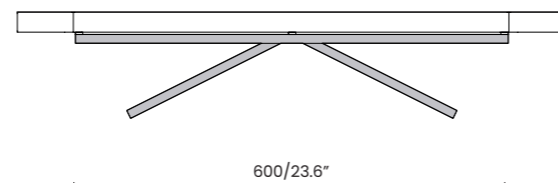

PYRAMIS

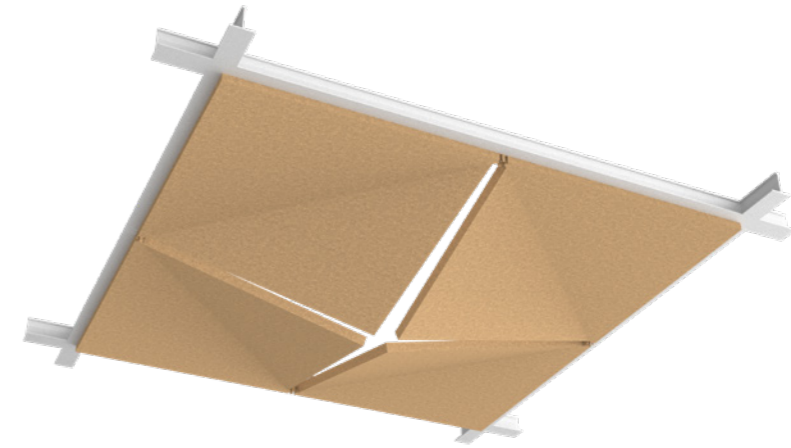

As the name suggests, the shape of the Pyramis panels resembles the volume of a pyramid. This configuration captures the interplay between light and shadow.

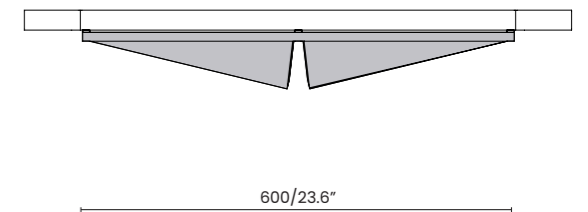

VENTO

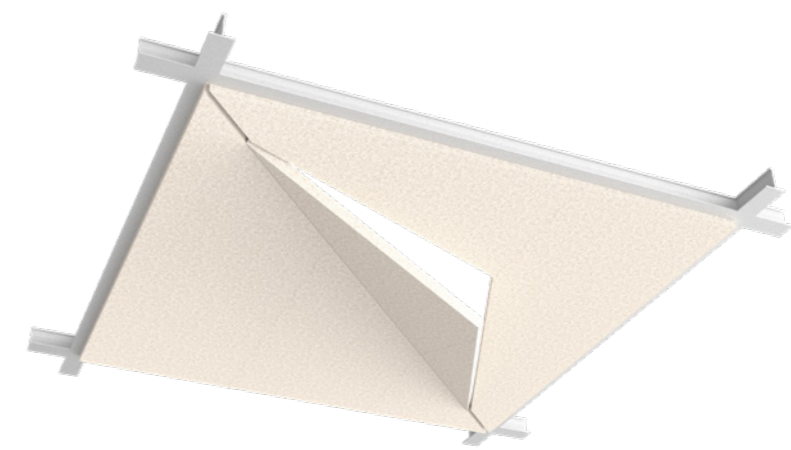

The Vento panel features well-defined, simple yet provocative lines due to its volumetric character. The resulting compositions with this model are dynamic, a quality further enhanced by the panels' magnetic attachment system.

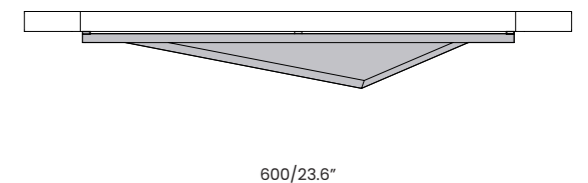



PARALLELA

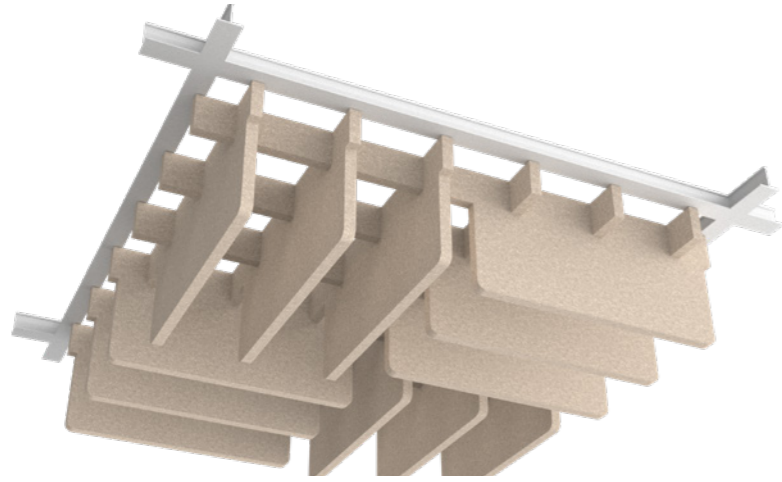

The Parallela acoustic solution is notable for its minimalist and repetitive geometry, which not only introduces a striking rhythm to the space but also amplifies both the visual appeal and the acoustic quality.

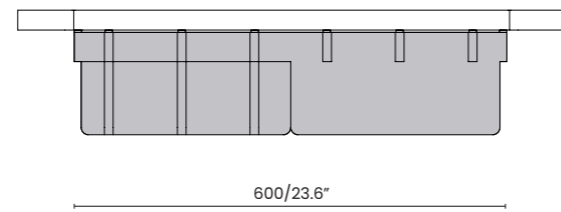

MAGNETIC VOLUMETRIC CEILING PANELS





MAGNETIC FLAT CEILING PANELS

The magnetic version of the flat ceiling panels, in addition to their easy installation, offers a wide range of attractive designs that completely cover the ceiling grid.

The sleek design of the Flat Panels enhances the ceiling area with visual interest while preserving the room's height, making them an ideal solution for spaces with low ceilings.

Features and benefits

- All panels are made from PET-Felt, known for its excellent acoustic properties.
- The magnetic panels provide an easy installation process.
- The Magnetic Flat Ceiling Panels Collection seamlessly blends with any interior design.

Applications

- Magnetic Flat panels are available in a variety of designs and styles, offering options to suit any space.
- Grid ceiling can be customized with acoustic panels to improve both its functionality and appearance, all without lowering its height.

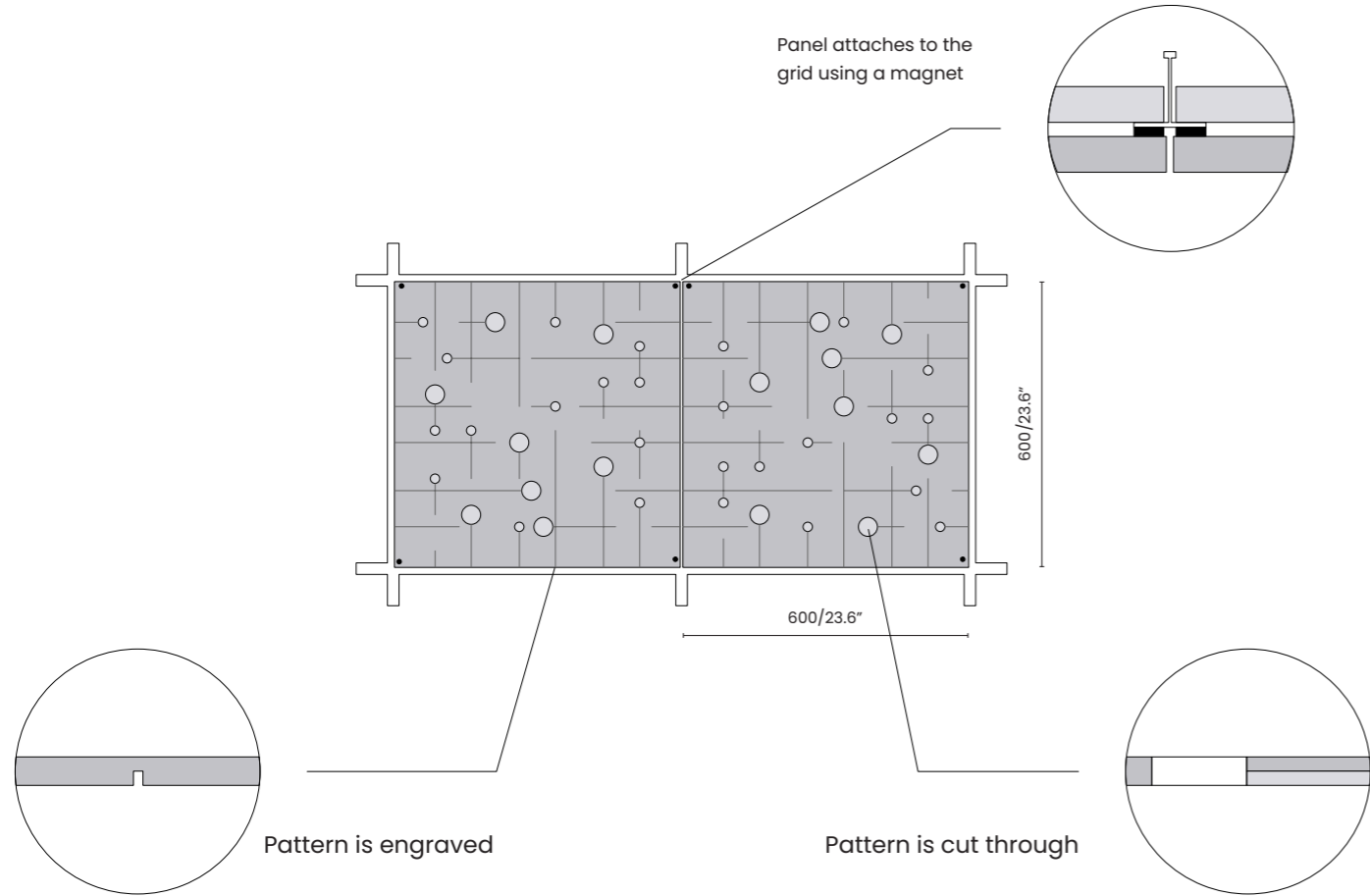

VIA

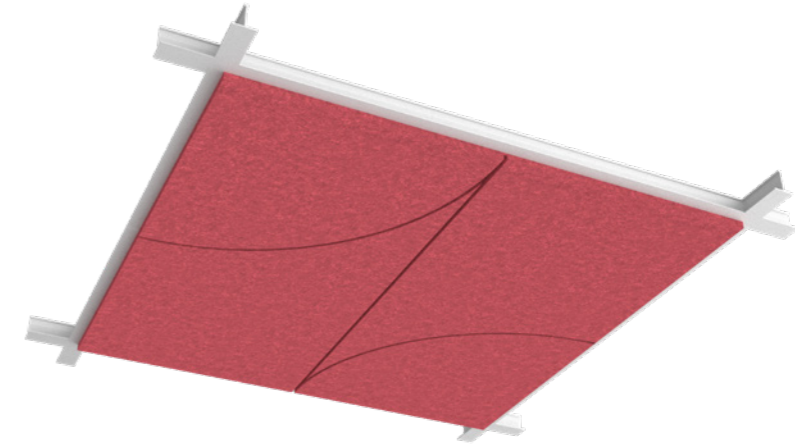

The Via panel features engraved curved lines that form a minimalist and refined pattern. This design not only enhances visual appeal, but also delivers enduring acoustic performance.

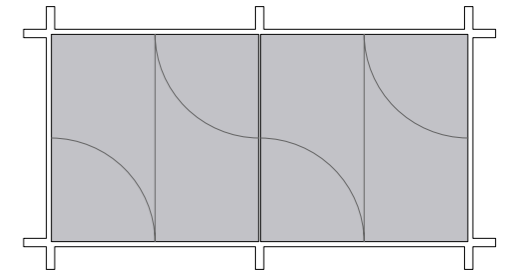

FAVO

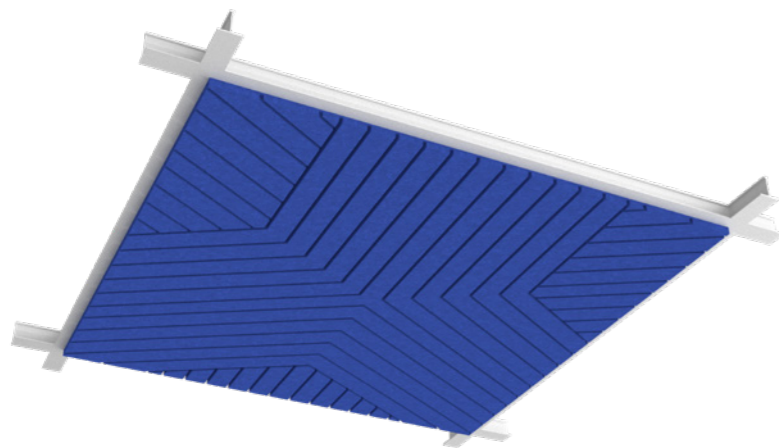

Favo is an acoustic solution featuring a seamless design that showcases a repetitive, yet elegant rhythm. Its unique aesthetic and sound-absorbing qualities make it an ideal choice for enhancing the ambiance of various interior spaces.

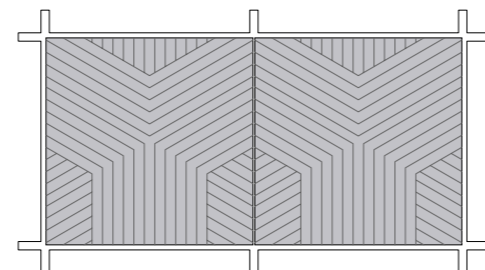

INTERSECTIO

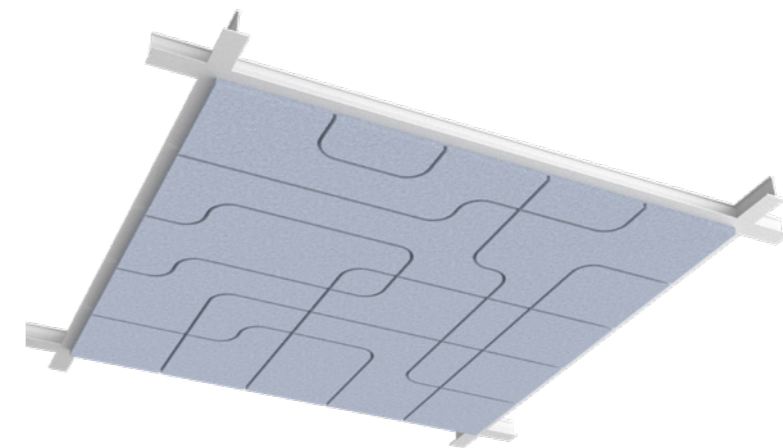

Intersectio stands out with its overlapping lines that create a seamless, playful, and captivating design, while also delivering excellent acoustic performance for any indoor environment.

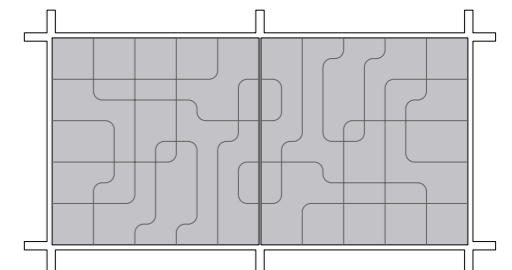



IRIS

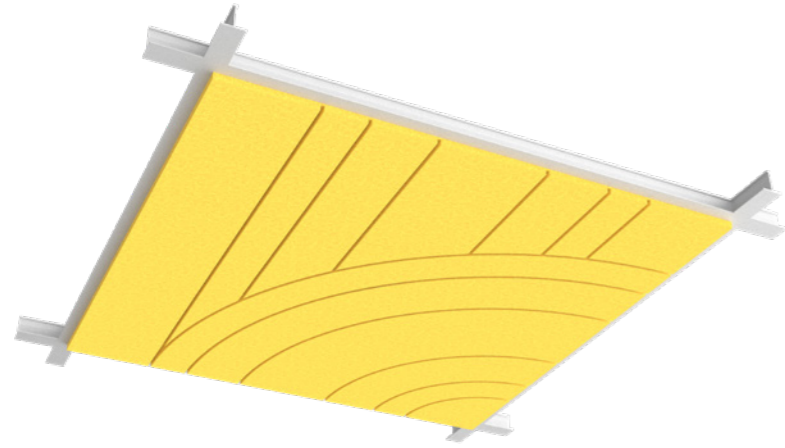

The Iris panel's design beautifully blends curved and straight lines, creating a range of vibrant and eye-catching patterns. offers both appeal and adaptability, making it ideal for various spaces.

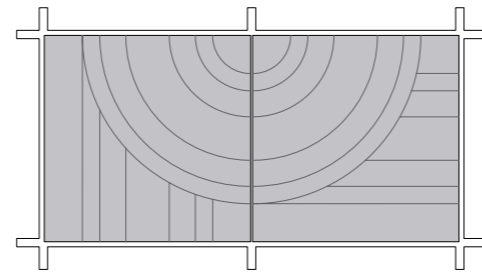

ARCO 2

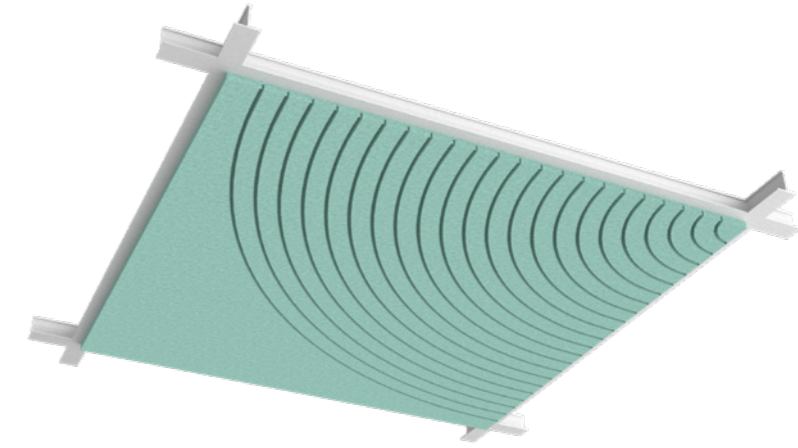

The Arco 2 acoustic ceiling panel features a series of engraved arcs on its visible surface, allowing for the creation of multiple wavy patterns.

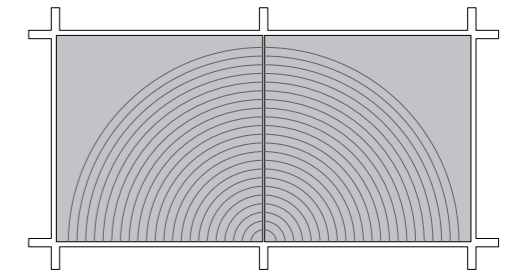

ARCO 1

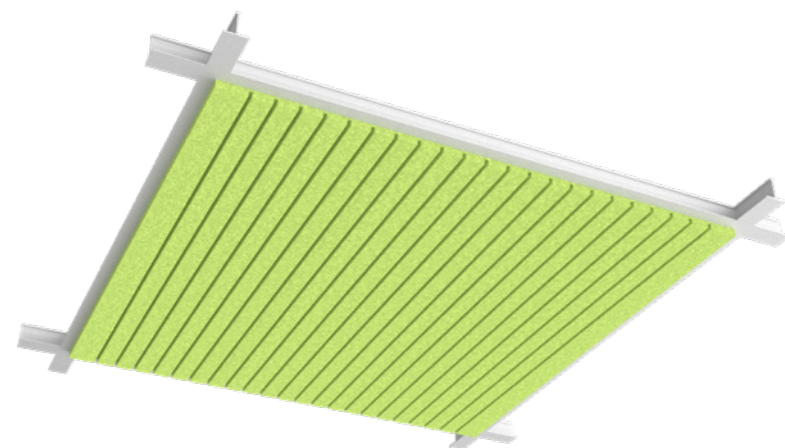

The repeated engraved lines on the Arco 1 panel create a calm and stable pattern, providing an acoustic solution that adds depth and elegance to the room.

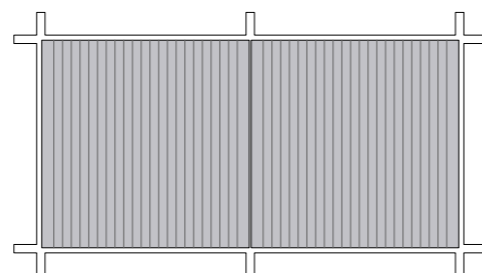

ARCO 3

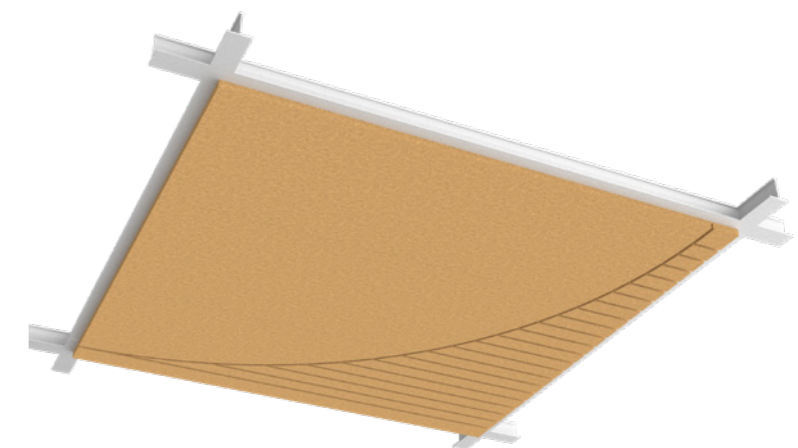

Arco 3 draws inspiration from the design of the Arco 1 and Arco 2 panels, maintaining the aesthetic direction of repeated lines to create a versatile and rhythmic design.

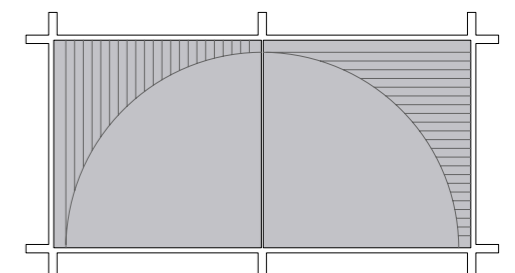



SOPRA 1

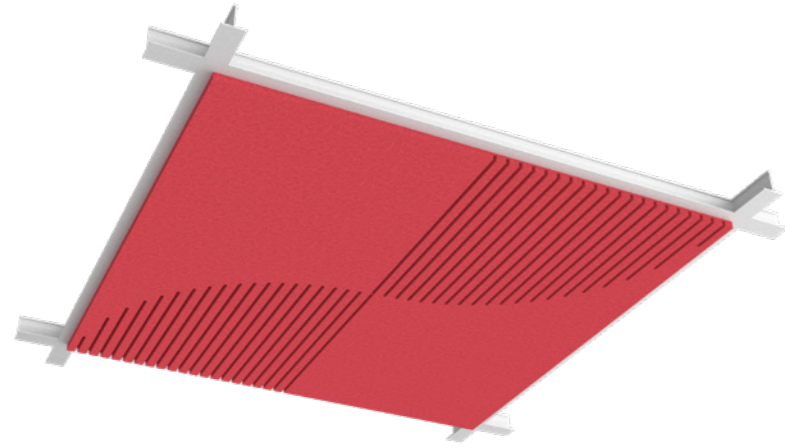

The simple, yet elegant arrangement of Sopra 1 provides a clean, modern look while enhancing acoustic performance.

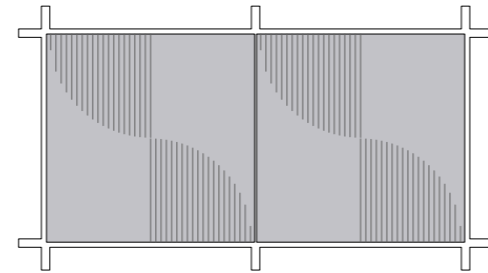

SOPRA 3

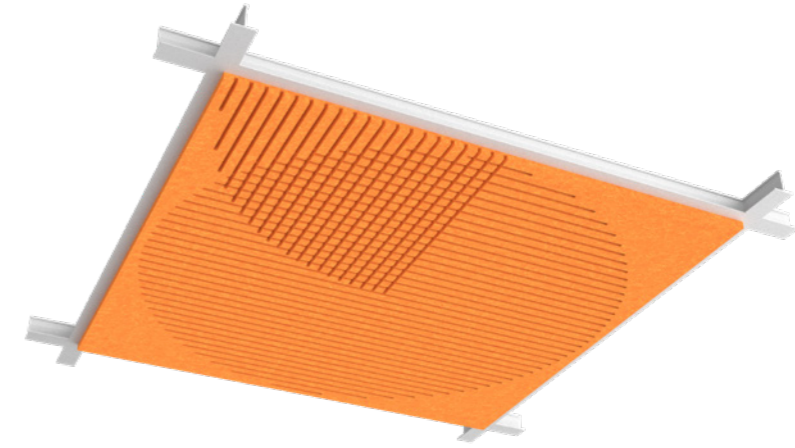

The combination of the patterns from the Sopra 1 and Sopra 2 panels creates a third design in the Sopra collection. This new model features a more elaborate and detailed pattern, providing a visually striking look

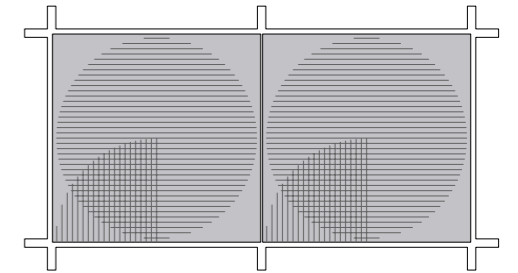

SOPRA 2

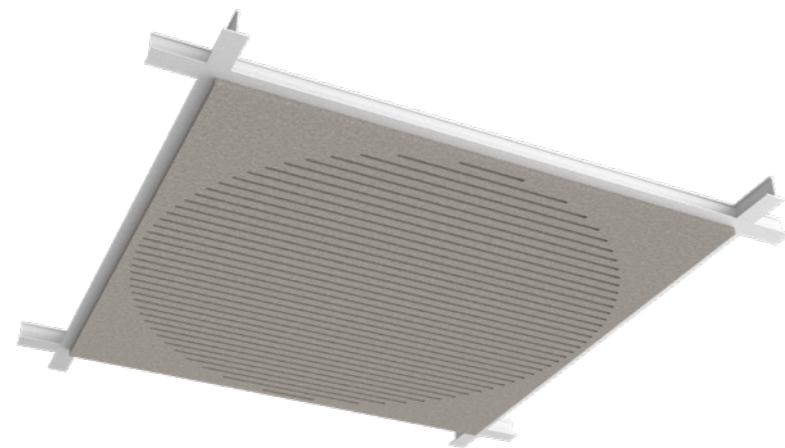

The Sopra 2 ceiling acoustic panel reimagines the Sopra 1 design by featuring engraved lines that form a circle, introducing a circular element to balance the formal rectangular grid.

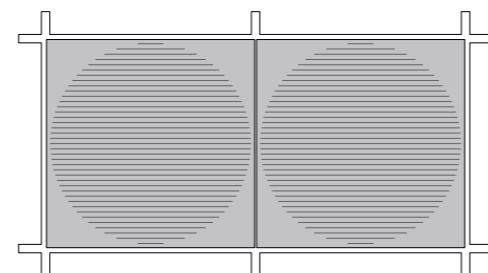

ILLUSIO 1

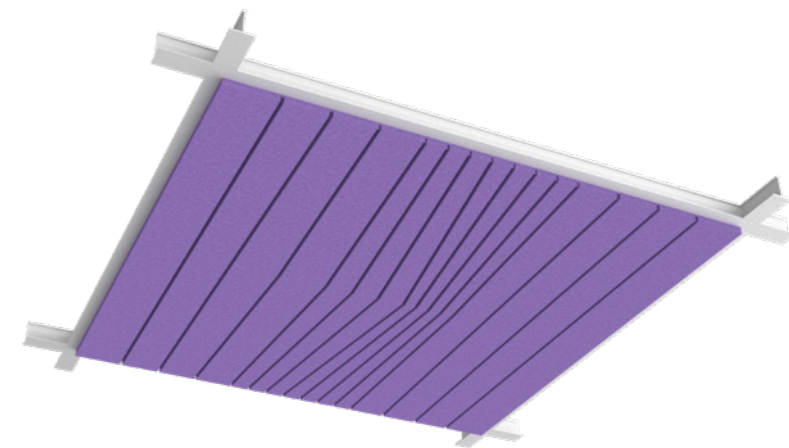

Illusio 1 is an acoustic ceiling panel distinguished by its visually appealing approach, featuring the concept of optical illusion.

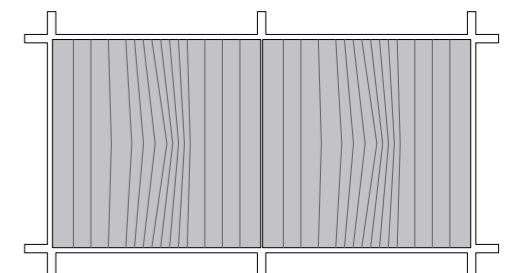



ILLUSIO 2

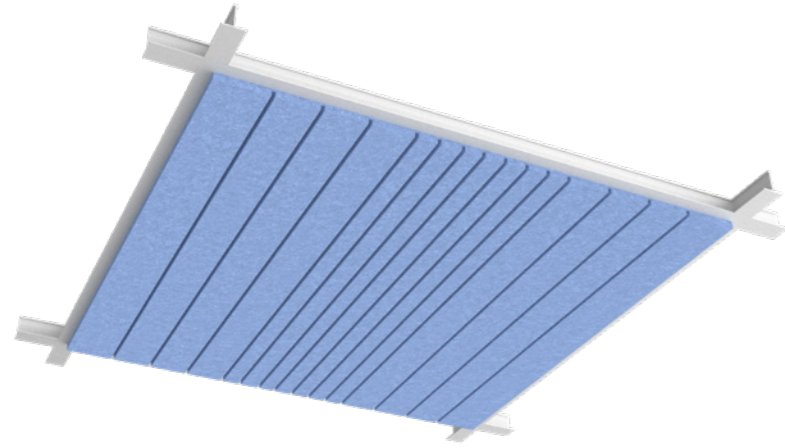

The Illusio 2 panel showcases a subtle aesthetic. It retains the stylistic concept of optical illusions, utilizing straight lines to achieve a more subtle and understated visual impact.

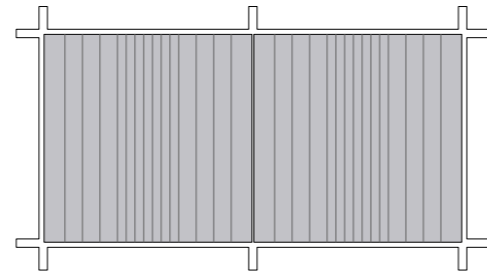

DULCIS

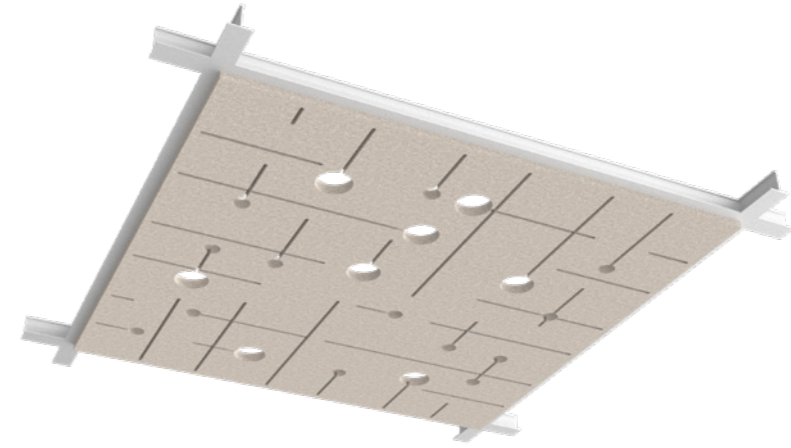

Dulcis makes a notable visual impression with its vibrant, engaging, and bold design. It provides outstanding acoustic performance, combining visual excitement with practical functionality.

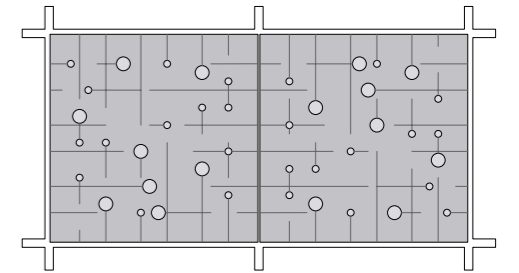

RETE

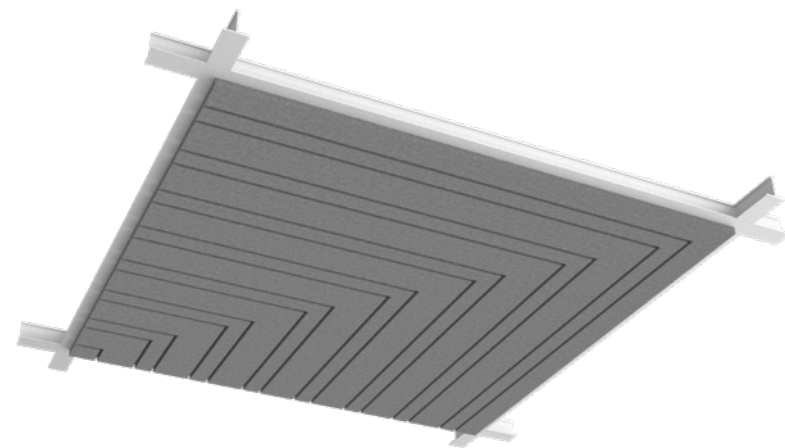

The Rete acoustic ceiling panel is distinguished by its engraved rectangular lines, which add a classic touch to the overall pattern created on the ceiling using these panels.

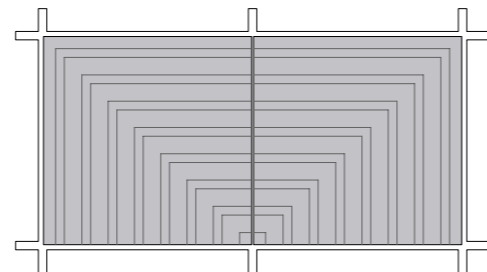

DISPERGO

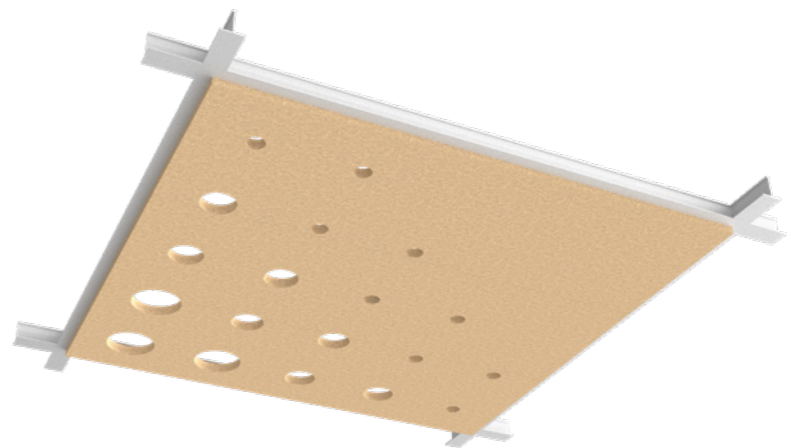

Featuring a subtle and friendly design, the Dispergo acoustic panel can be seamlessly incorporated into a wide range of environments.

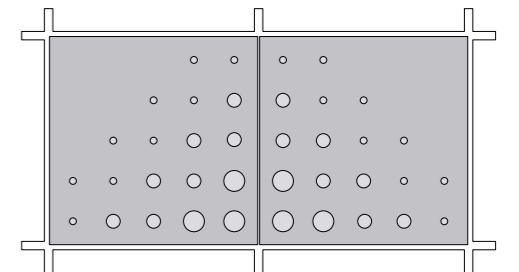



ANGOLO 1

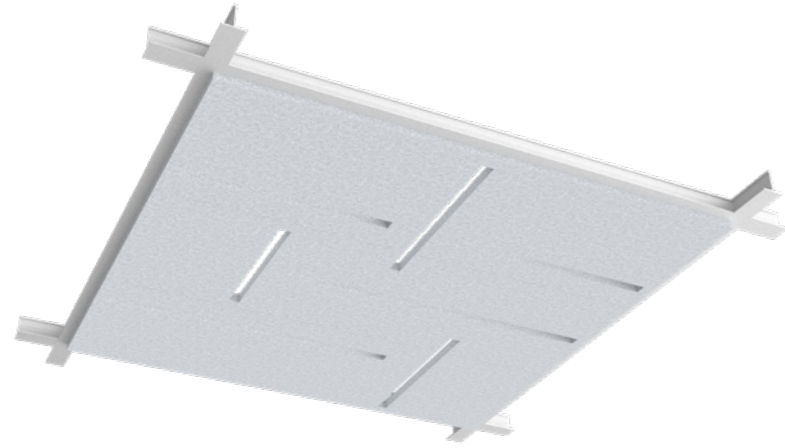

The cut-outs of the Angolo 1 acoustic pane create a precise and elaborate geometry, from which results a notably refined pattern.

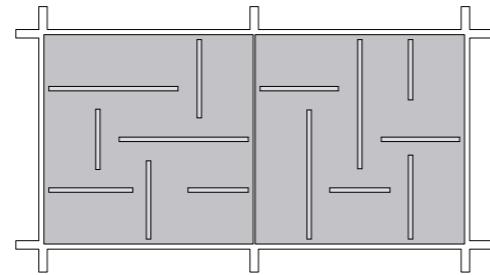

TRANSVERSUS

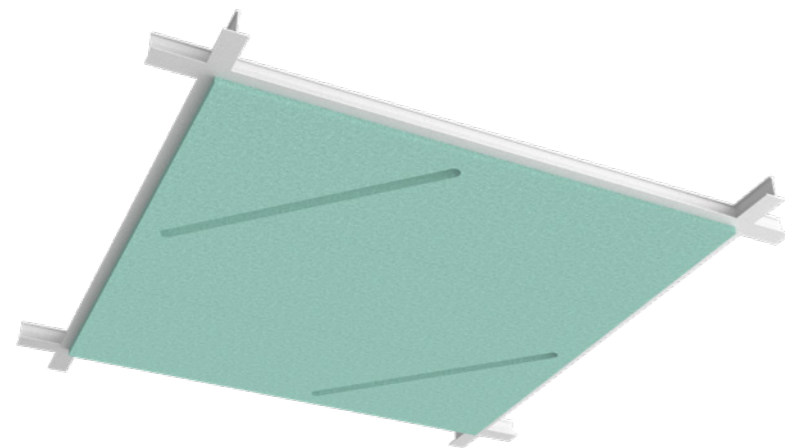

In addition to its acoustic properties, the Transversus panel is distinguished by its minimalist design with a range of possibilities for creating striking patterns on the ceiling.

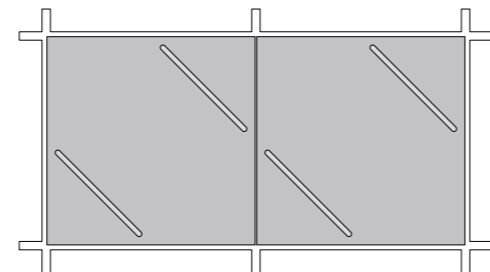

SECARE

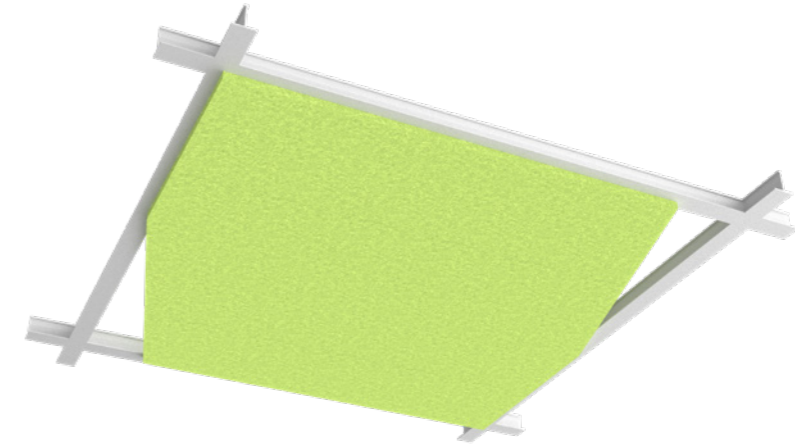

Secare is perfect for improving both the acoustic performance and the aesthetic appeal of a space. Crafted in a minimalist style, Secare offers an elegant solution with a variety of compositional options.

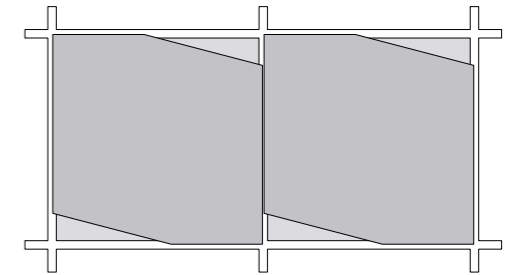

CALEUM 1

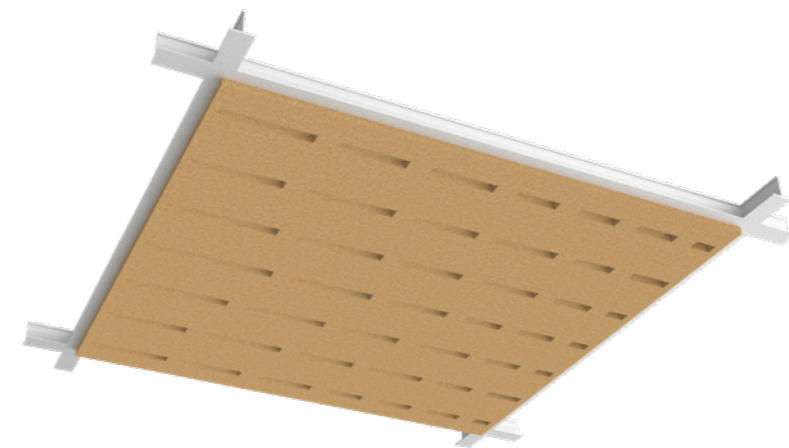

The Caleum 1 acoustic panel stands out with its distinct, calm, and sequential aesthetic rhythm, creating a distinctive ambiance in any space where it is installed.

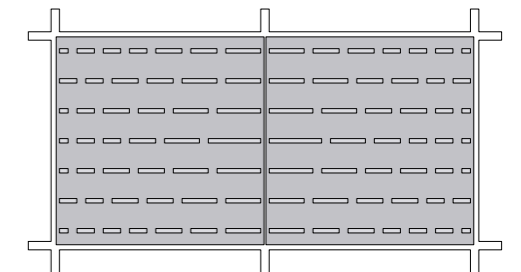



TONDE

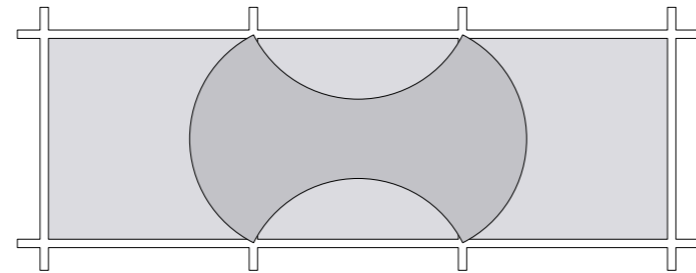
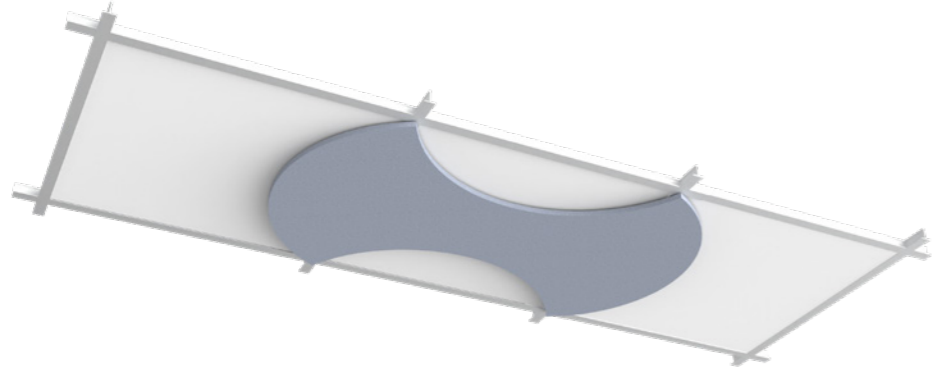

965/38"

Tonde acoustic panel features a versatile shape which offers flexibility, allowing for diverse configurations, attractive patterns on the ceiling grid.

PIATTO

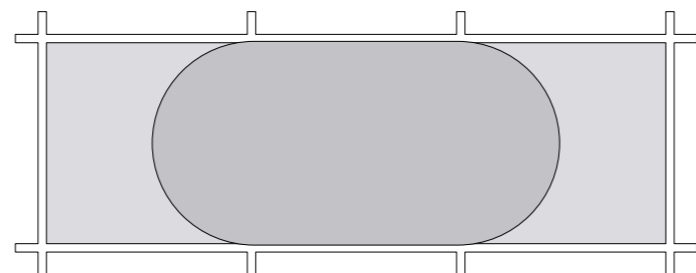
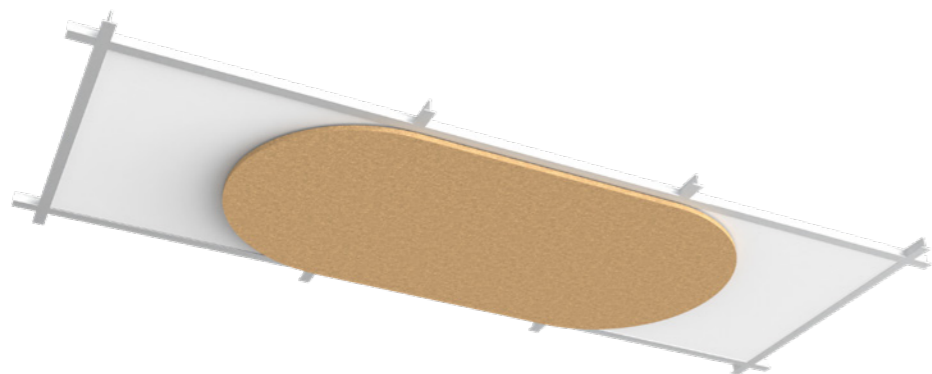

1166/46"

The simple, circular form of the Piatto acoustic panel offers a minimalist alternative to grid ceiling configurations. It is an ideal choice for contemporary interiors where both style and acoustics are a priority.



sharp design for timeless spaces

GRID FRAME

These ceiling frames, designed for both aesthetic appeal and functional enhancement, come in various styles, finishes, and materials to suit different design preferences.

Each frame is easy to install and can be used to create distinct visual focal points while incorporates acoustic panels for improved sound quality.

Features and benefits

- The frame is fully customizable which allows you to tailor the product according to your specific needs.
- Its easy installation and flexible placement make it a versatile addition
- Adding acoustic ceiling panels, the ceiling grid will be transformed into a modern and effective design element

Applications

- The wide range of materials and size configurations available for the ceiling grid makes it adaptable to any interior space.

2X2

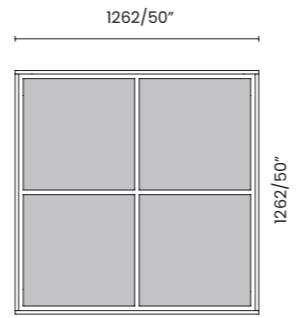
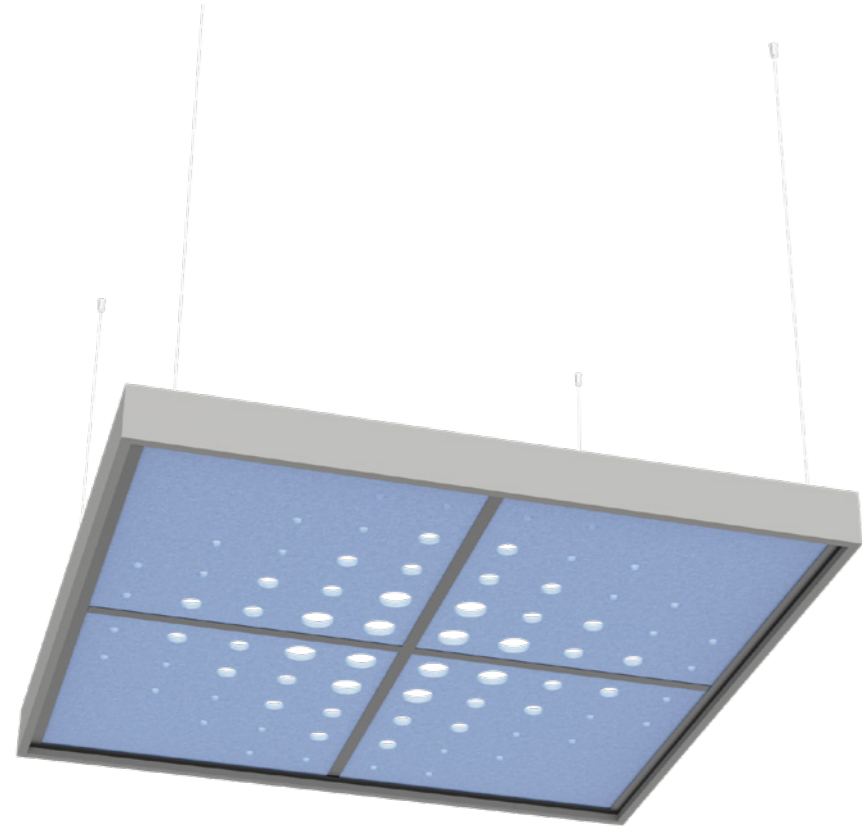

2X4

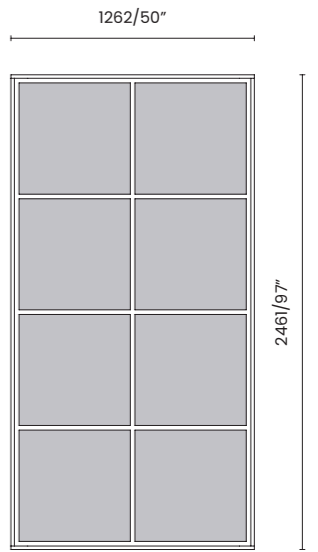

2X3

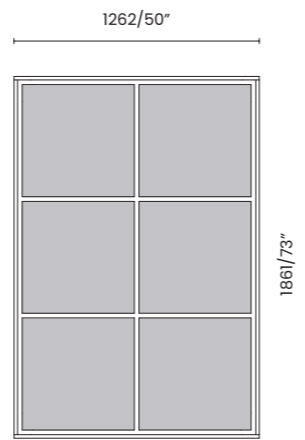
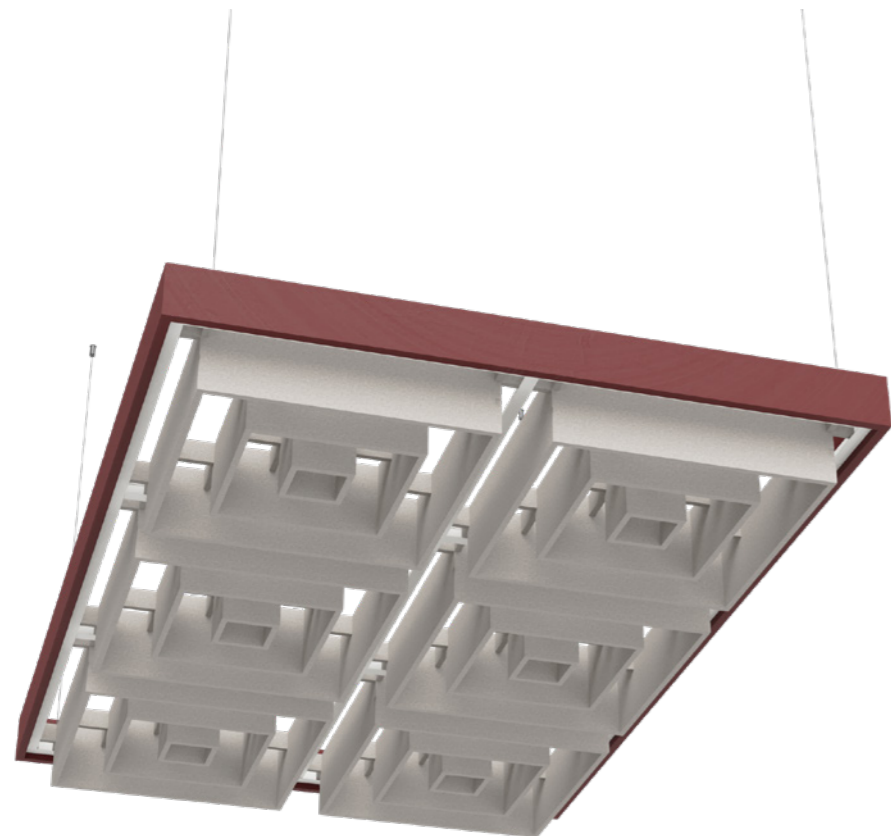

3X3

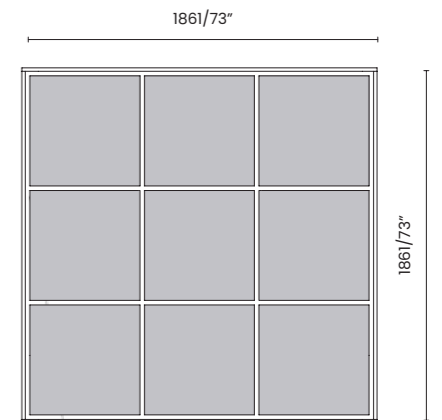
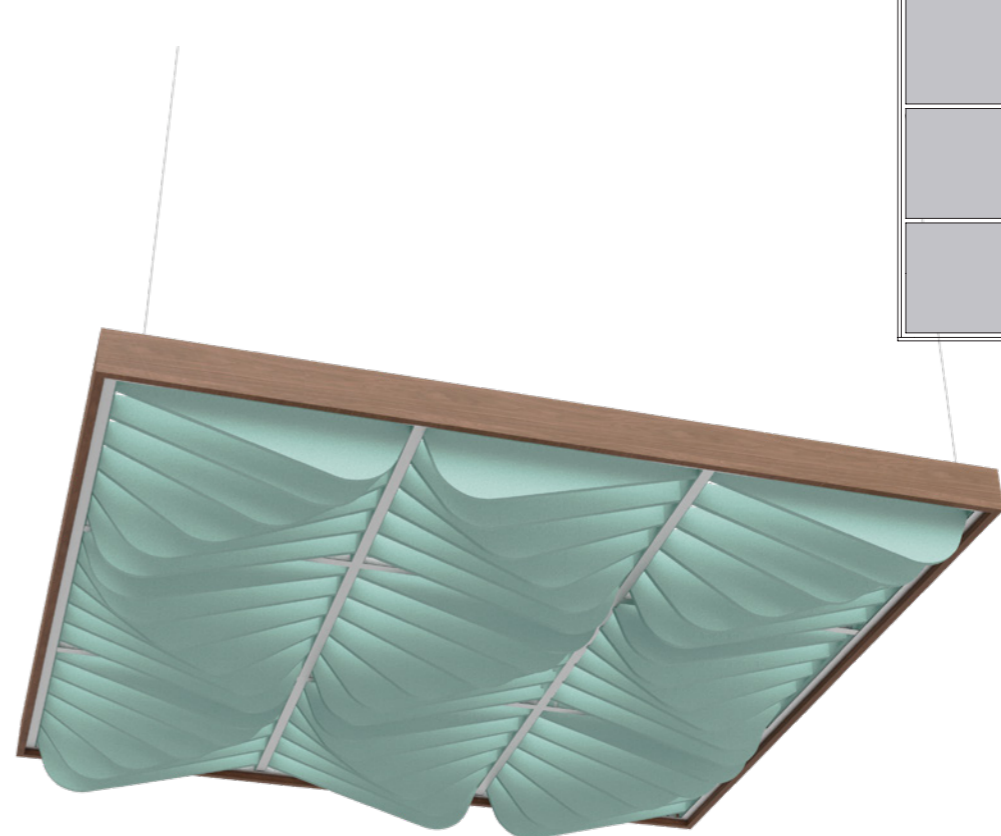

3X4

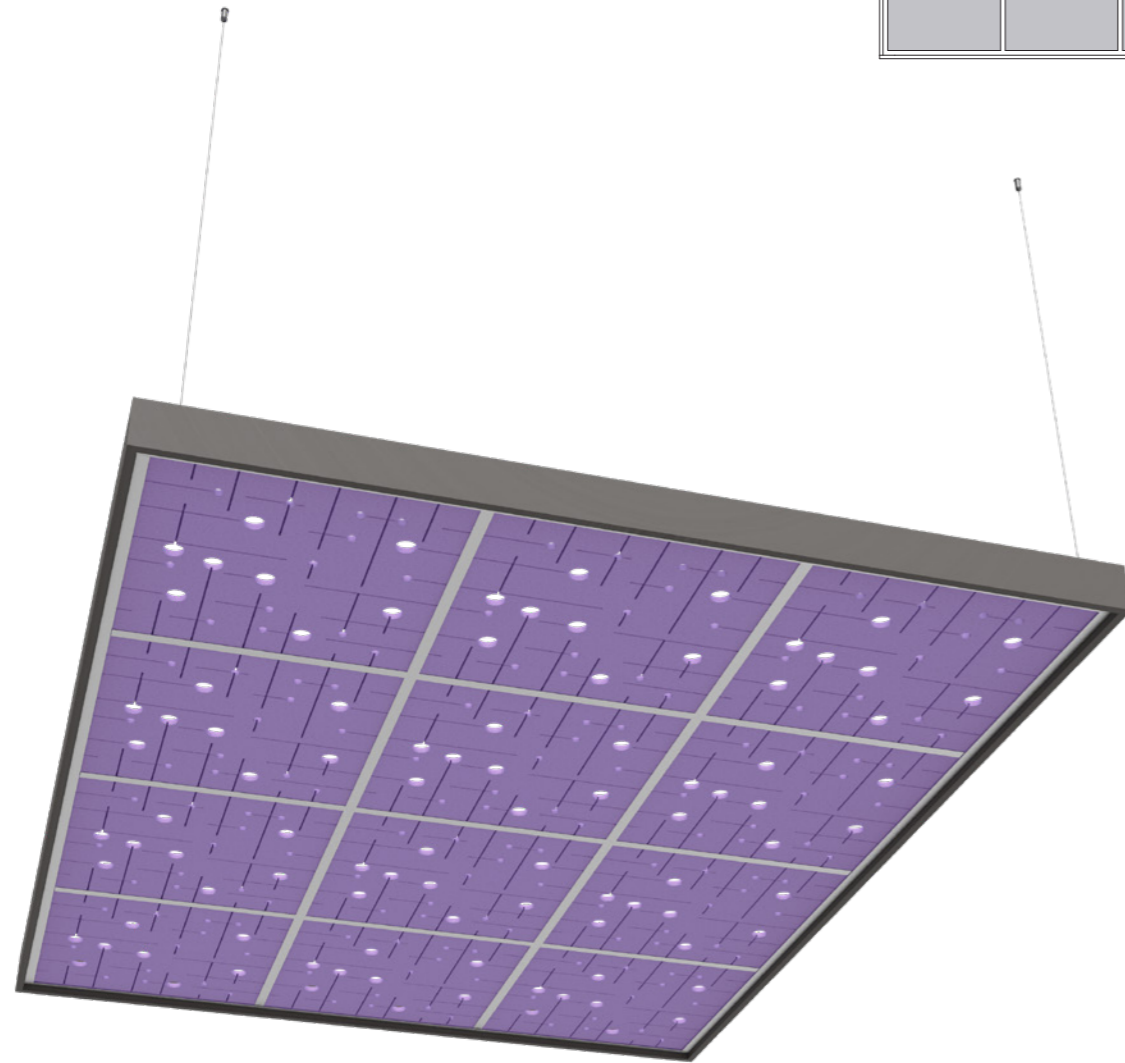
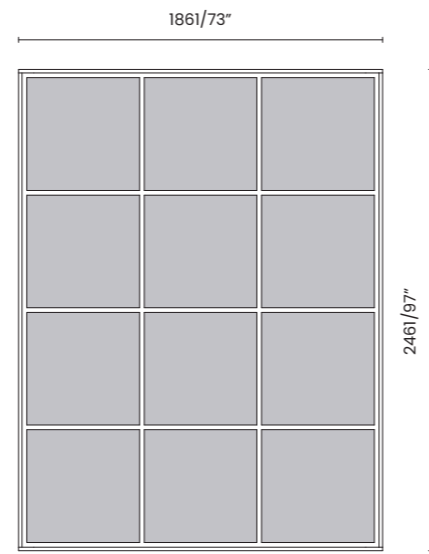

4X4

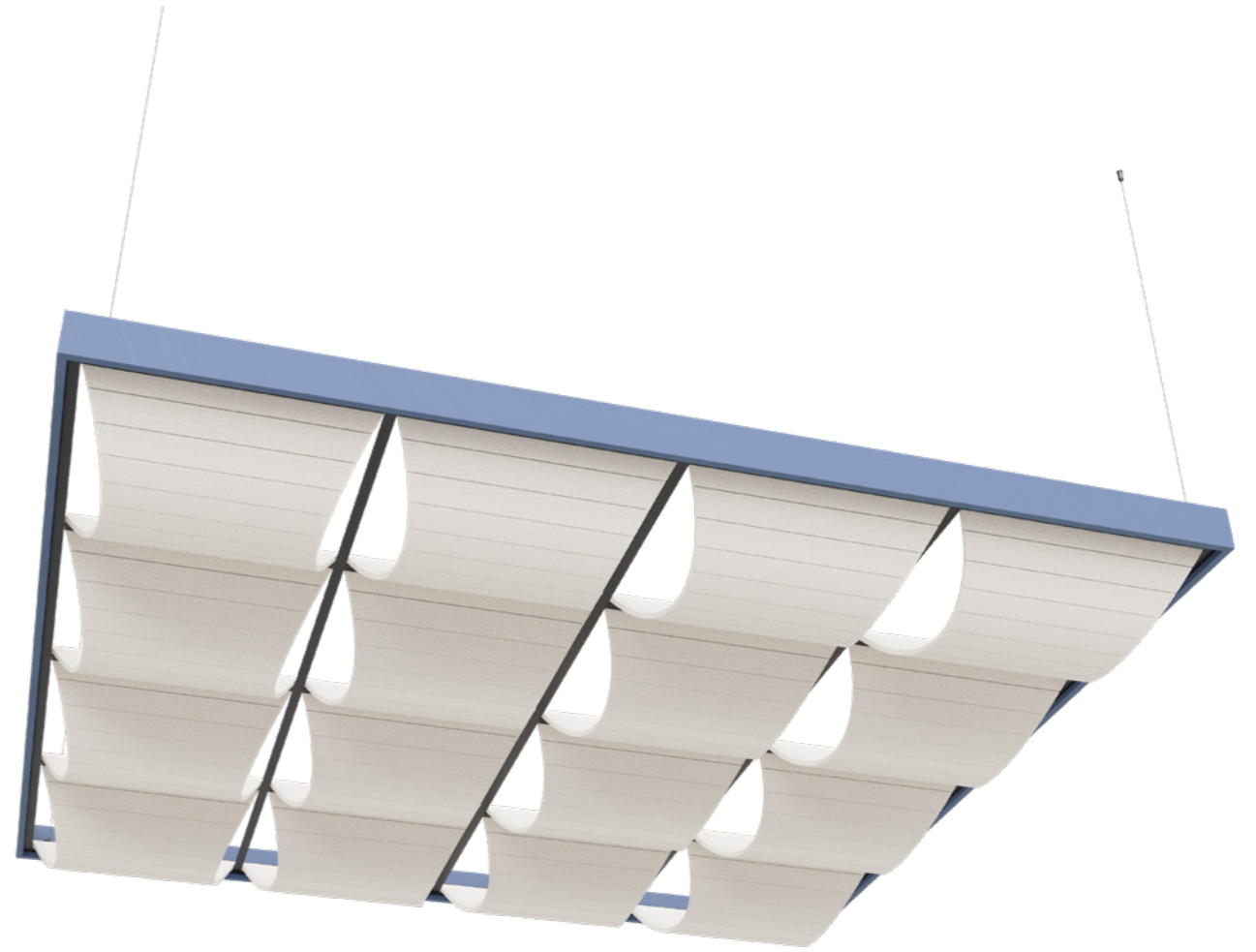
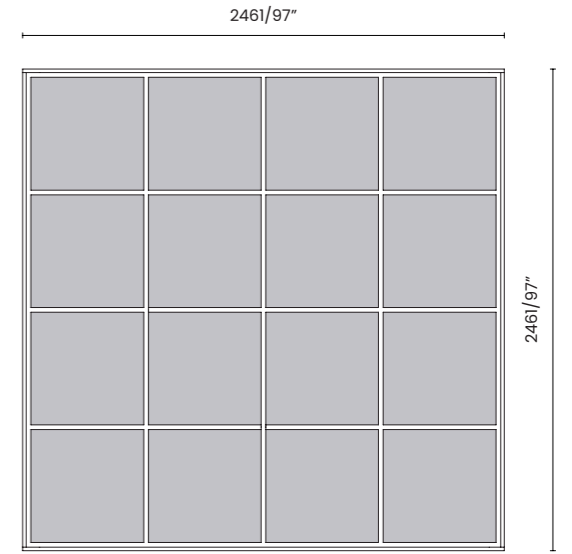



COLOR SWATCHES

We provide a wide variety of color options for PET-Felt and materials used in ceiling grids to ensure these products can seamlessly integrate into a wide range of interior spaces.

PET-FELT

Weight	Material	Thickness	Applications
2400 g/mp	PET-Felt	12 mm	Indoor areas only

Color

Slight color deviations may occur since the PET Felt panels are made from recycled fibers. It is recommended to use the same batch per project. When placing an order take a margin into account for unforeseen changes or additions to a design plan.

STANDARD



NON-STANDARD



Fire Rating

B-s1, d0 classification
ASTME84 Class A

Environment

ASKIA PET is 50% recycled
ASKIA PET is 100% recyclable

DATASHEET PET-FELT BOARD 12 MM

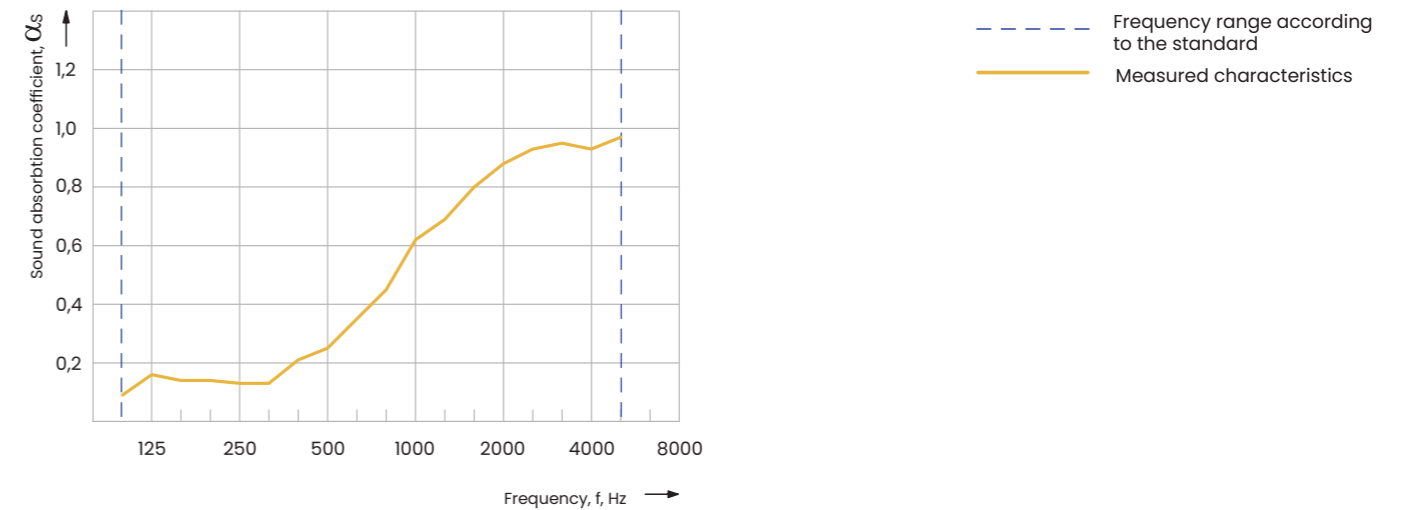

GRID FRAME

Multiple finishes

Opt for the mix of textures and colors that best suits your space, access the configurator to design your own unique combination.

Frame - Chipboard & Melamine

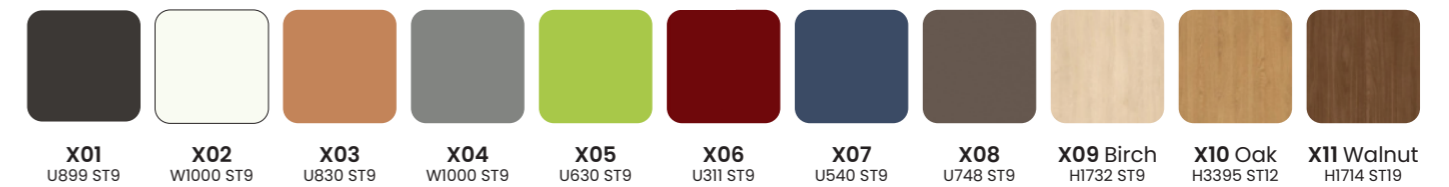

Profile - Metal



Grid width - 24mm

SUSTAINABILITY & EFFICIENCY

**We remain humble
in front of nature.**

Our acoustic panels are carefully crafted from PET-Felt, a sustainable material composed of 50% recycled content and fully recyclable. This choice reflects a commitment to environmental responsibility, supporting a circular economy by reducing waste and conserving resources.

Acoustic panels are designed to enhance absorption, attenuation and diffusion within an interior space. By optimizing how sound waves interact with the surfaces, they improve acoustic quality and create a more pleasant auditory environment. This ensures that sound is distributed evenly and effectively throughout the room, reducing echo and enhancing clarity.



Absorption



Attenuation



Diffusion



ASKIA