



ASKIA | 2022 EASYSIDE CATALOG

**In these ever evolving times,
workspaces are changing frequently,
adapting to one's needs and values.**

In response to the ergonomic challenges in the workplace, we developed a new range of desks that impresses with an innovative and functional design, as well as high product intelligence.

Designed with the main purpose of making workflows faster and easier, these desks bring a significant contribution to keeping the body and mind active, and are available in a variety of designs, colours and surface finishes.

LEG SYMBOLS



RECTANGLE



SQUARE



ELLIPSE



CIRCLE

DESK AND BENCH

pg 8

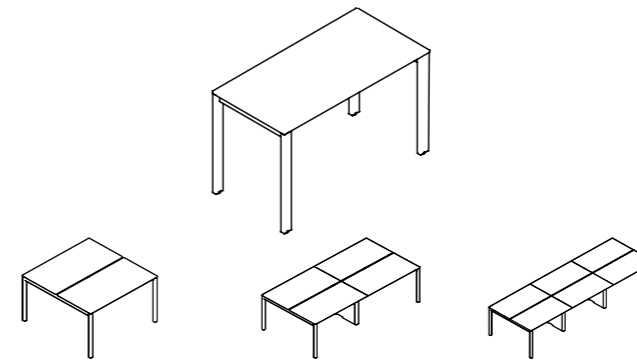

EXTENSIONS

pg 10

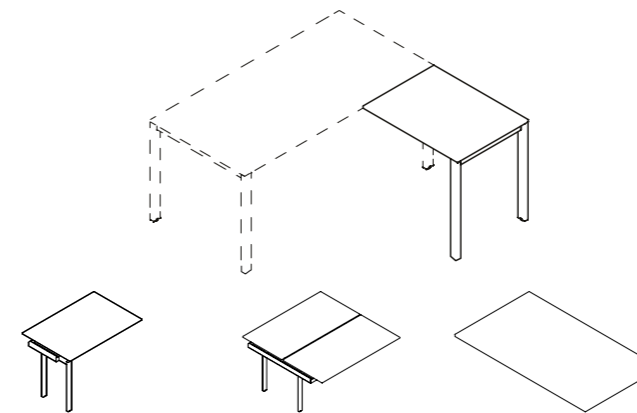

ISLANDS

pg 12

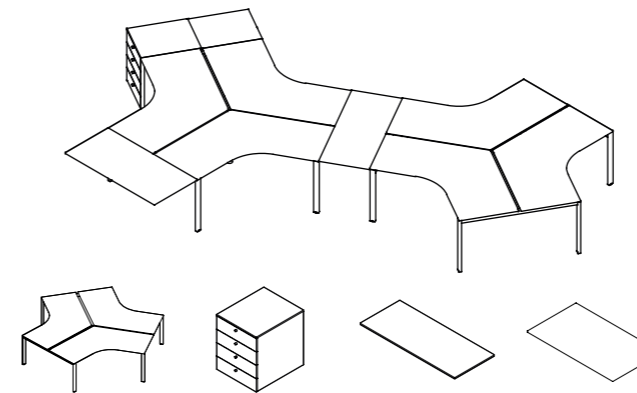

MANAGERIAL STORAGE DESK

pg 14

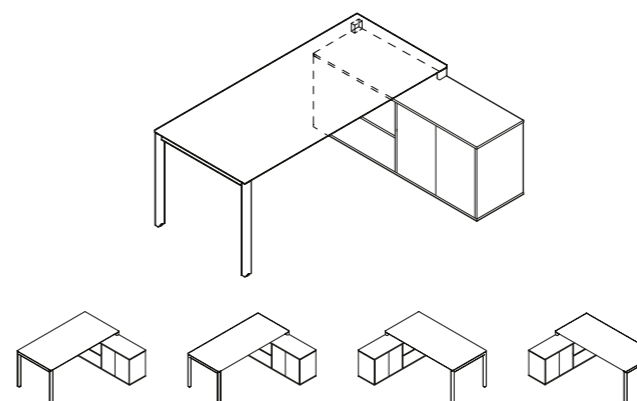

ROLLBOX

pg 16

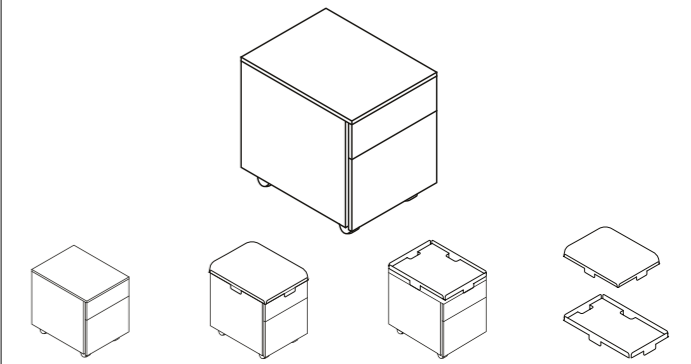

SIDEBORD

pg 18

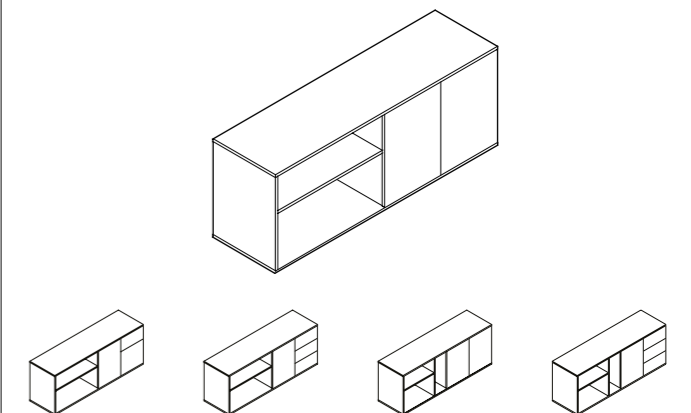

SCREEN FIXTURES

pg 20

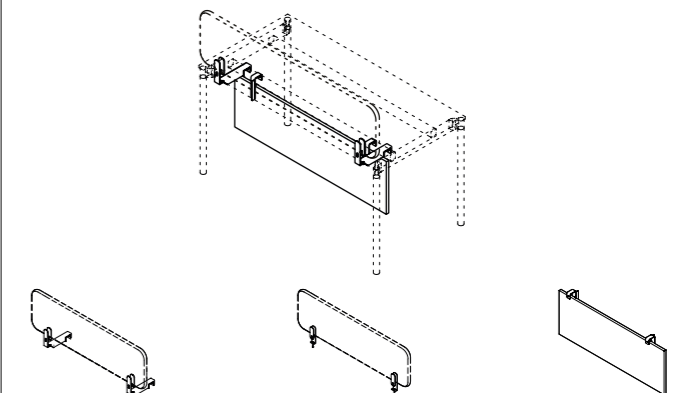

ACCESORIES

pg 22

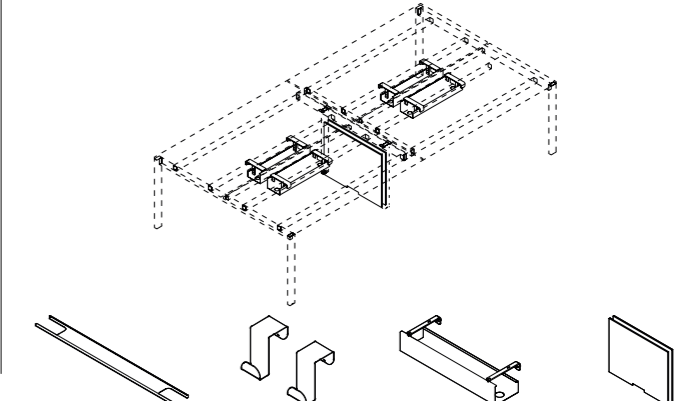



FRONT SCREEN
by ARS

DESK
by ARS

MANAGERIAL DESK
by ARS

BENCH for 2
by ARS

Great ideas come from great challenges.

Made with people and spaces in mind, these desks and benches make up the **EASYSLIDE Collection**. The name comes from the worktop's sliding mechanism, a standard option, that provides easy access to all cables and accessories.

The collection features 4 leg profile options available in multiple finishes.

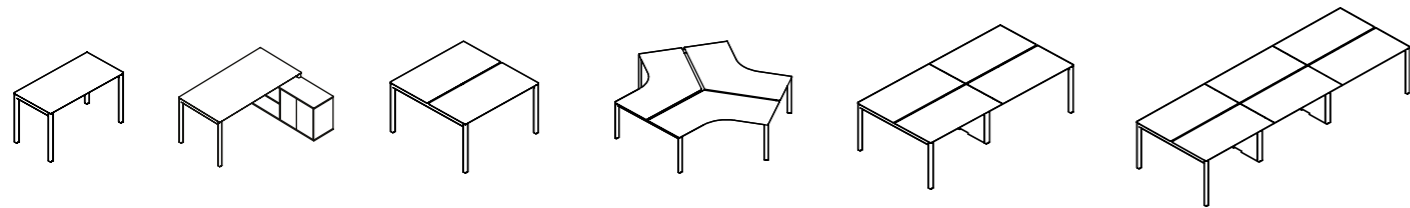

Make it your own

Be there or be square. Or not, you can choose between 4 available leg shapes and multiple finishes to give your space a personalized look.

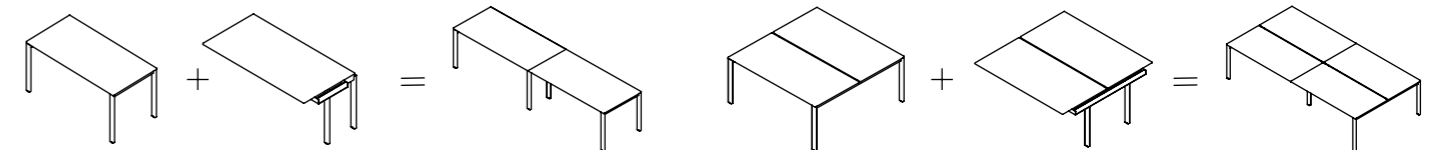
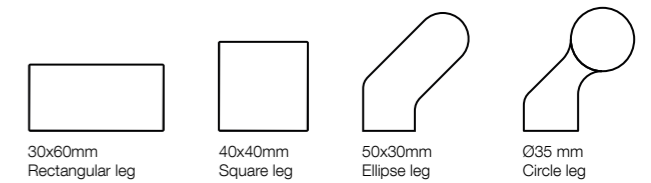

01

Easy to configure your space

The **EASYSLIDE** desk family suits offices with various organisation systems: Designated workspaces, Co-working spaces, Hot-desking.

Easy to create your workspace

Instead of the basic legs, you can attach middle sections on the base framework and create benches as long as you want.

02



Easy access to your cables

Just **slide** the top to access your cables, battery banks, power bricks, sockets, or whatever you want to hide there, we don't judge.

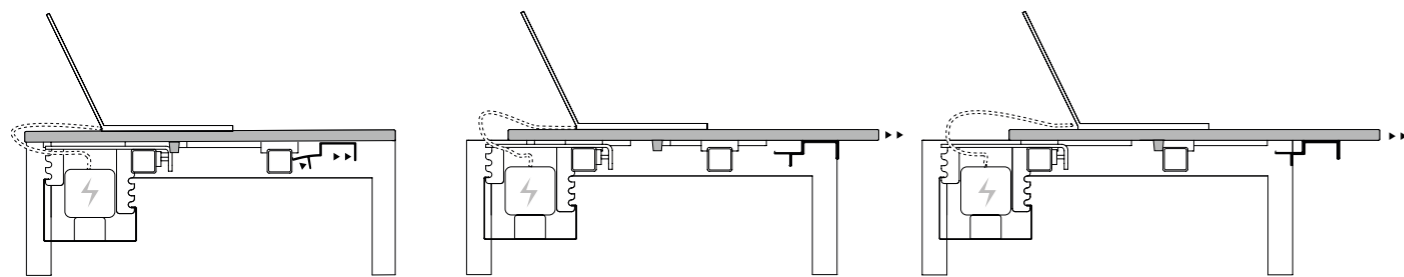

Step 1
Unhook the tab and pull the handle towards you

Step 2
Pull continuously until the cable tray is revealed.

Step 3
The stopper will prevent the countertop from sliding completely.

03

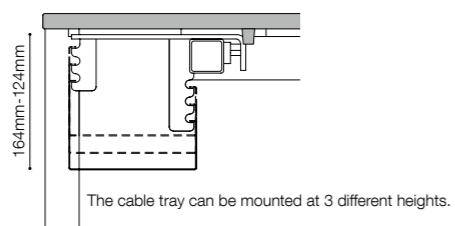

The cable tray can be mounted at 3 different heights.

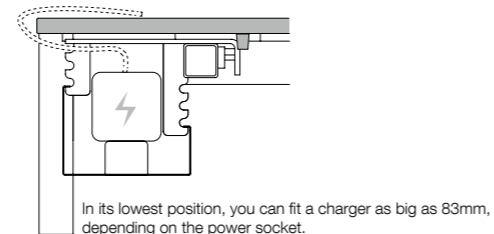

In its lowest position, you can fit a charger as big as 83mm, depending on the power socket.

Easy as 1 2 3!

The framework is easy to assemble. Using just an allen key, attach the legs and then the cable tray. The top is attached without any screws using quick fix connectors.

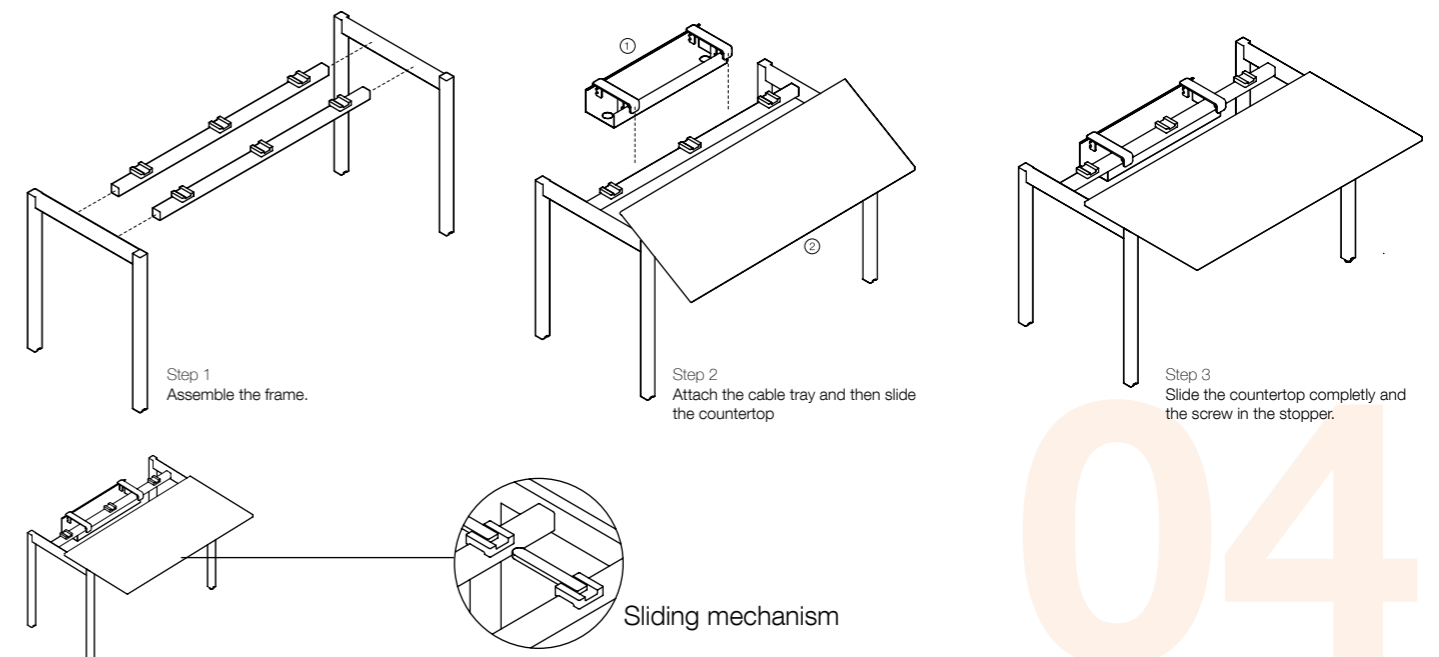

Step 1
Assemble the frame.

Step 2
Attach the cable tray and then slide the countertop

Step 3
Slide the countertop completely and the screw in the stopper.

Sliding mechanism

04

LEG TYPES



CIRCLE 35



ELLIPSE 30x50



SQUARE 40x40



RECTANGLE 30x60



COUNTERTOP TYPES



ROUNDED PLYWOOD CORNER



STRAIGHT CHIPBOARD CORNER



DESK AND BENCH



NOMAD STOOL
by ARS

FRONT SCREEN
by ARS

ROLLBOX 3
by ARS

Make it easy.

Private office or open space? Either way the **EASYSLIDE** family will help you find the best layout for the office floor.

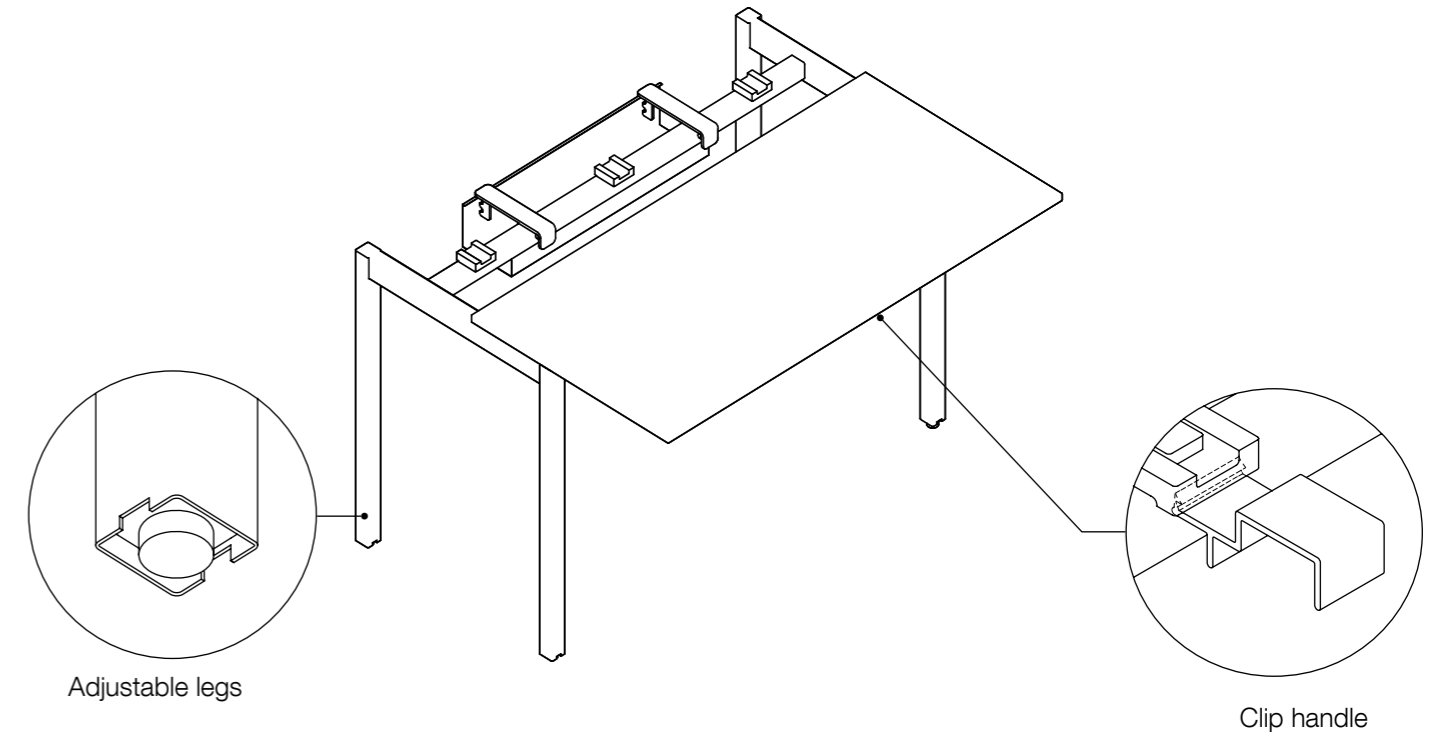

Adjustable legs

Clip handle

DESK

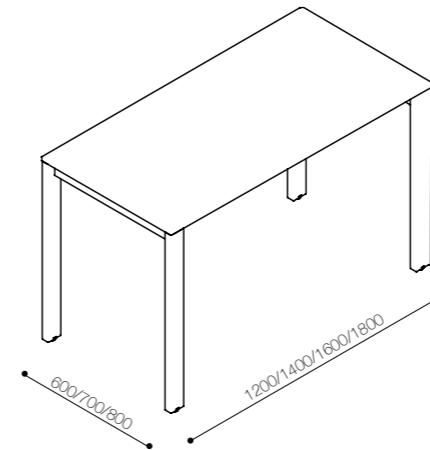

BENCH DESK for 2

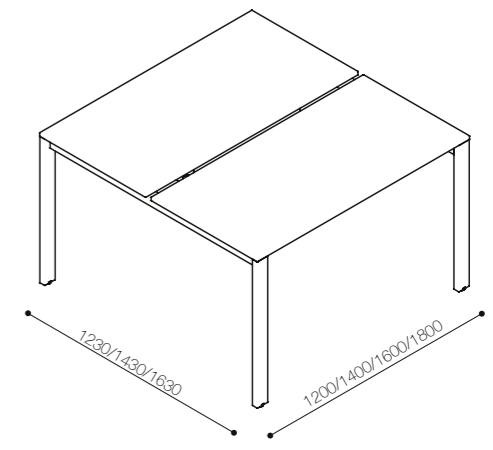

BENCH DESK for 4

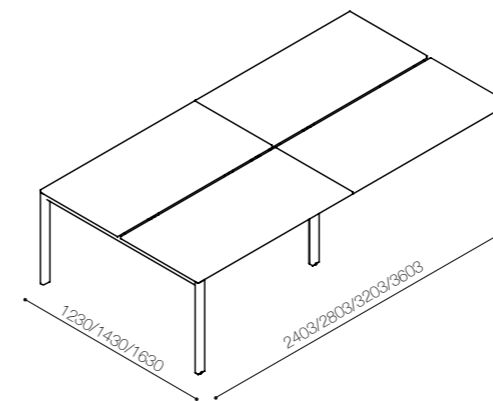

BENCH DESK for 6

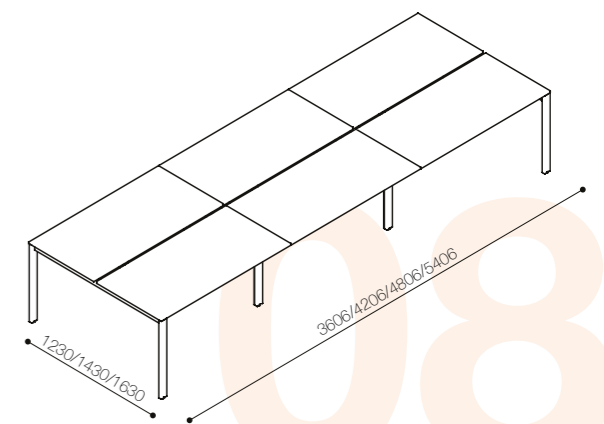

EXTENSIONS



Sometimes what you're given is simply not enough.

DESKS can clutter and get busy really fast. Our desks are easily **expandable** with **console extensions** or **L extensions** for more usable desk space.

Module Extension for desk*

*only for desk with 800mm depth

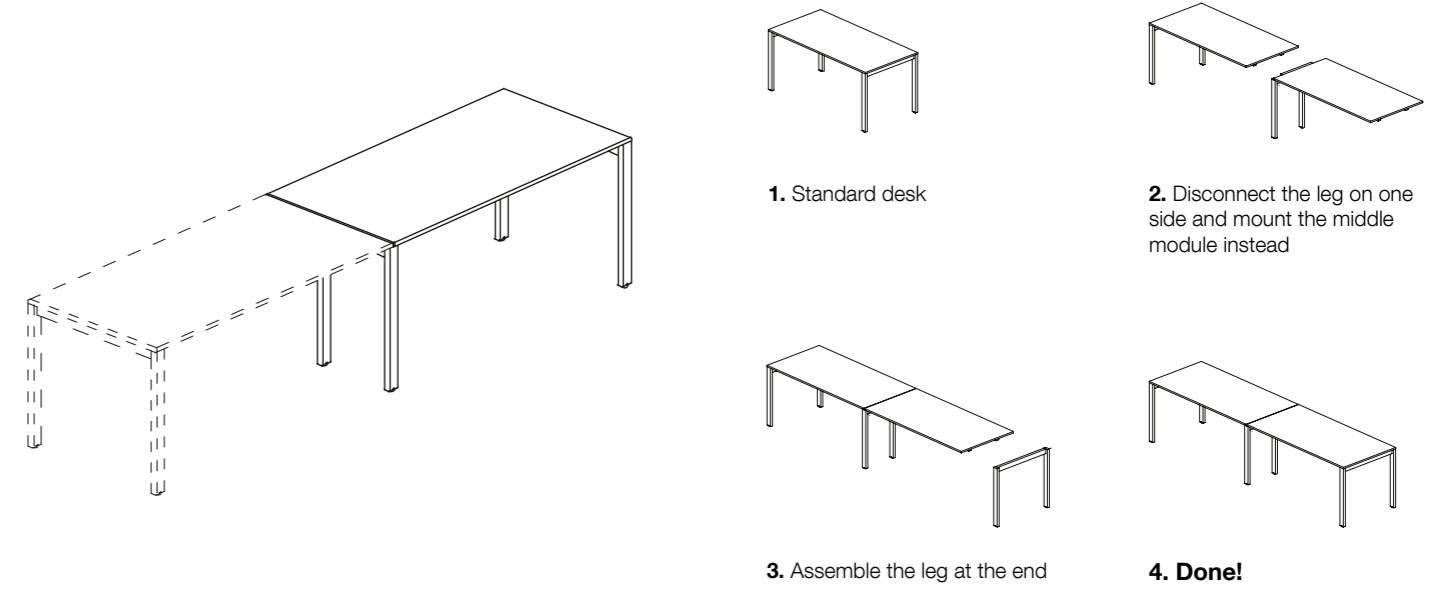

Module Extension for bench desk

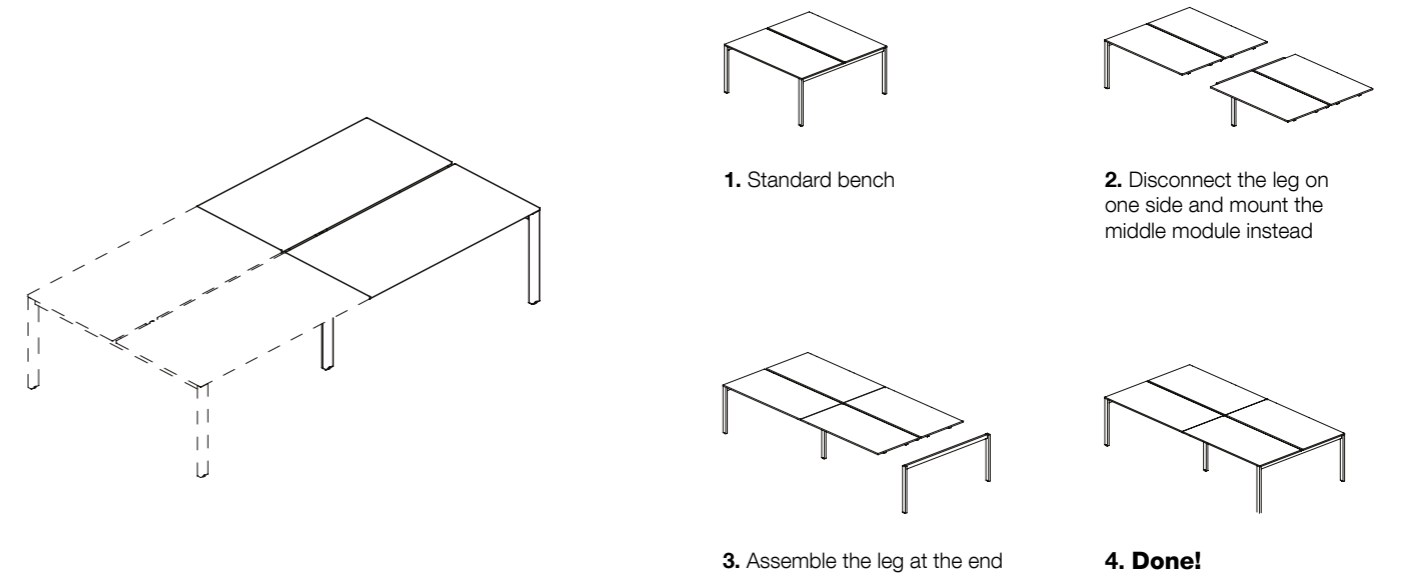

L Extension for bench desk

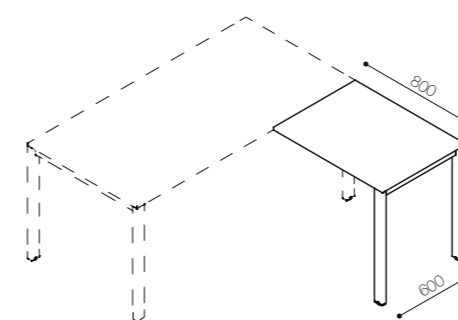

Console Extension for bench desk

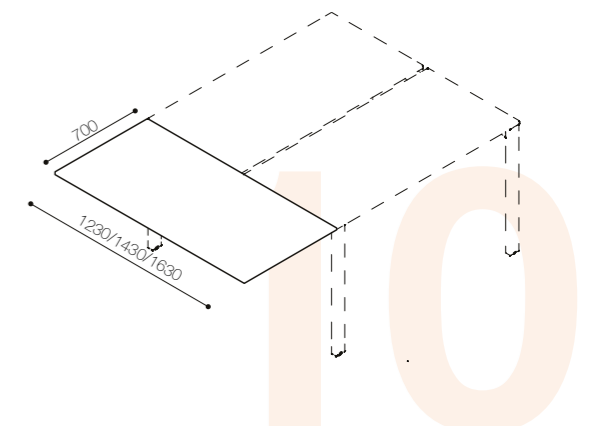

ISLANDS

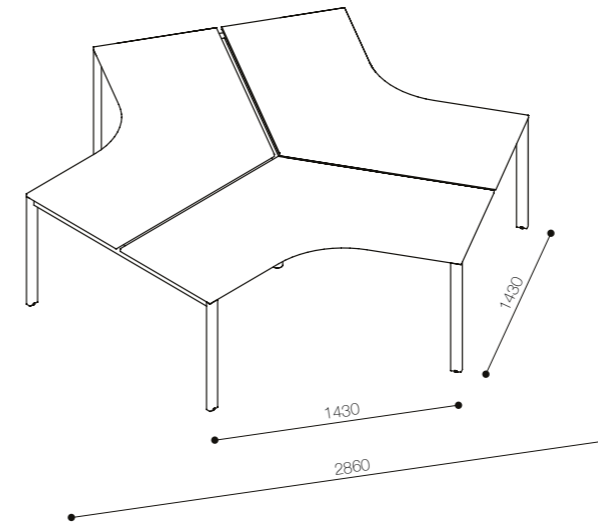

ISLAND EXTENSIONS

CONSOLE EXTENSION

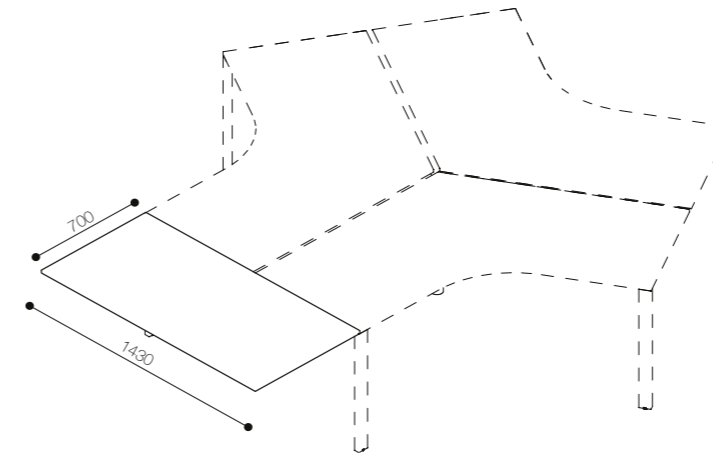

CABINET CONNECTOR

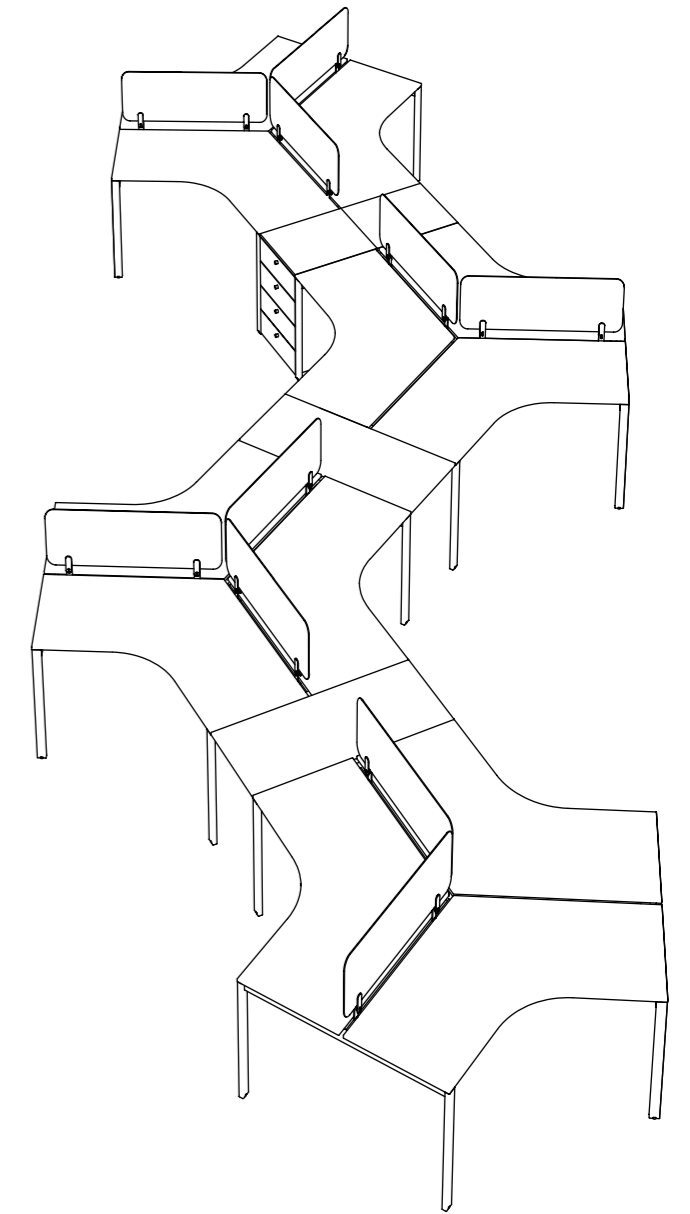
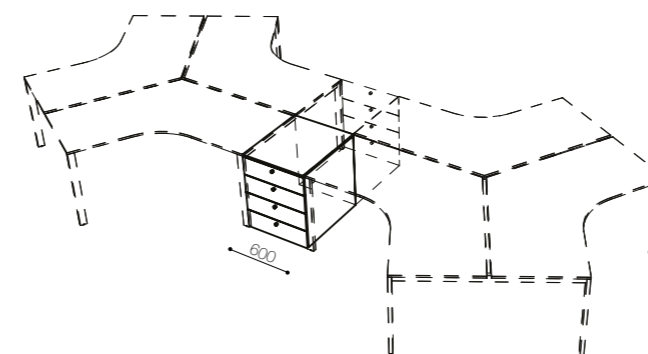

WORKTOP CONNECTOR

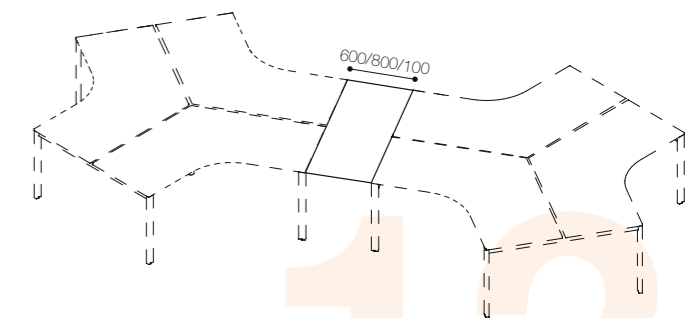

12

MANAGERIAL STORAGE DESK



Wherever there is stuff to do, someone needs to keep track of it.

For an individual who needs more storage space in their close quarters, the **MANAGERIAL DESK** is a great option, because it has the benefits of the Easyslide Desk, alongside a sideboard cabinet with 6 available layouts. Available for desks with 800mm depth and 1600,1800 width.

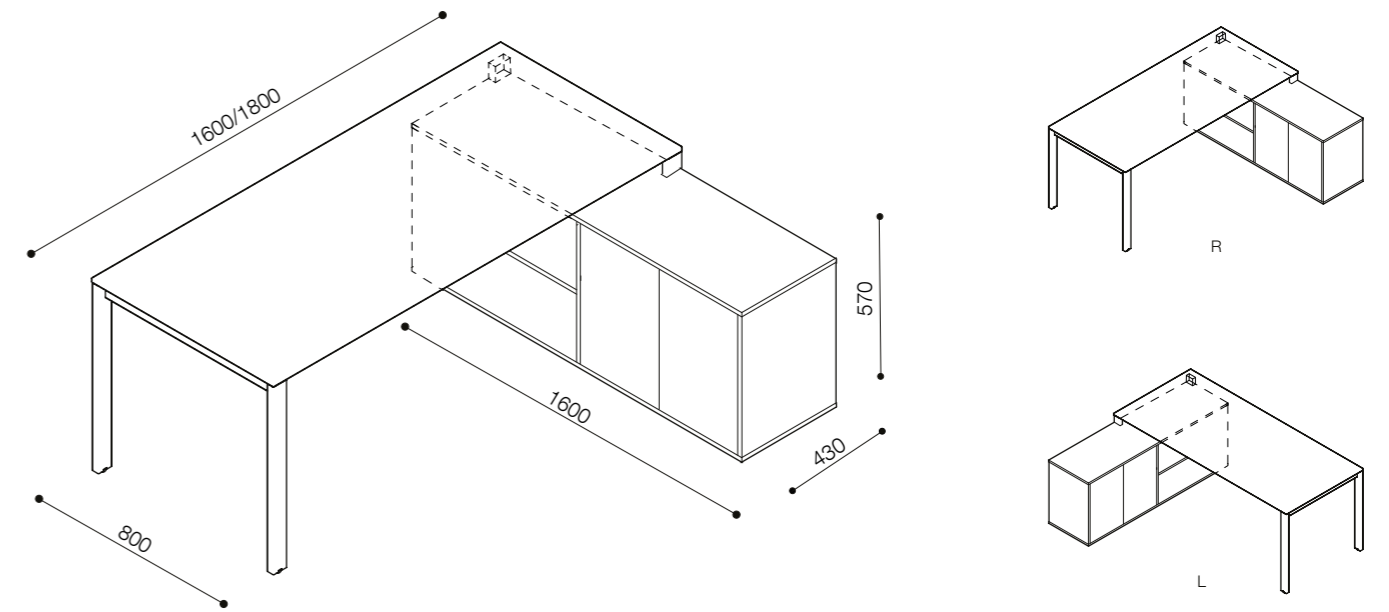

Managerial storage options

Storage 01

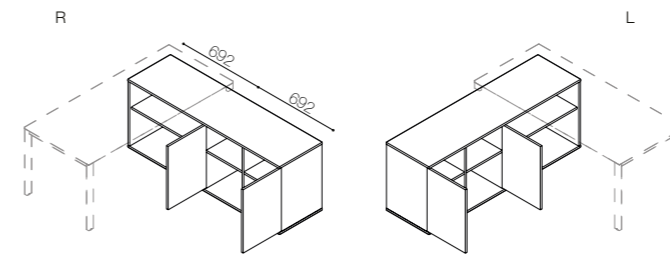

Storage 04

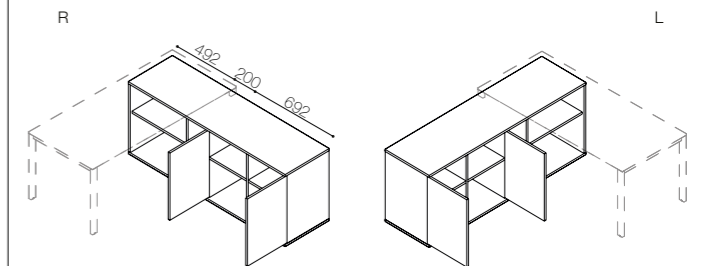

Storage 02

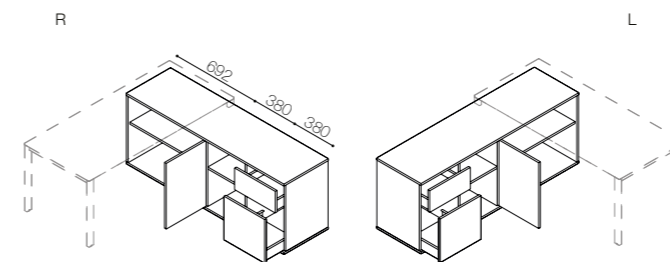

Storage 05

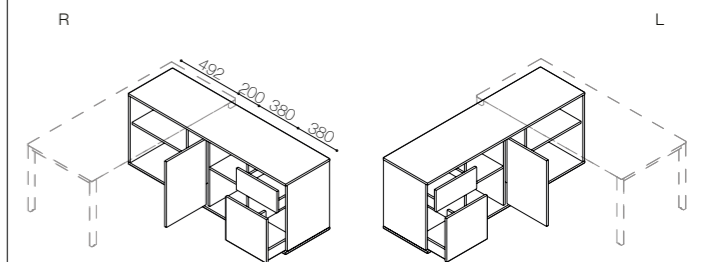

Storage 03

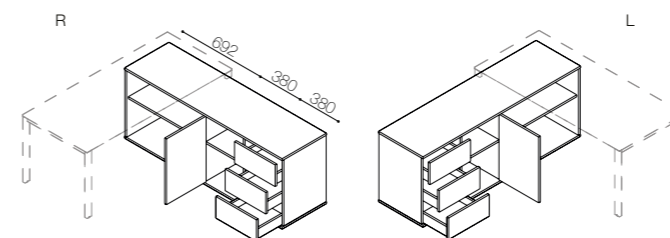

Storage 06

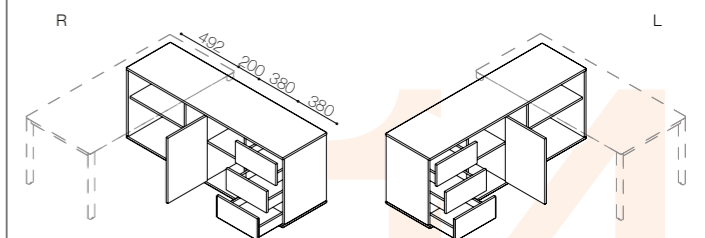

ROLLBOX

Mobility, storage and seating.

The **ROLLBOX** comes in a 2-drawer, 3-drawer or 4-drawer configuration and is available in 3 sizes. Add a tray or a seat for when your co-worker comes to you for a quick chat.

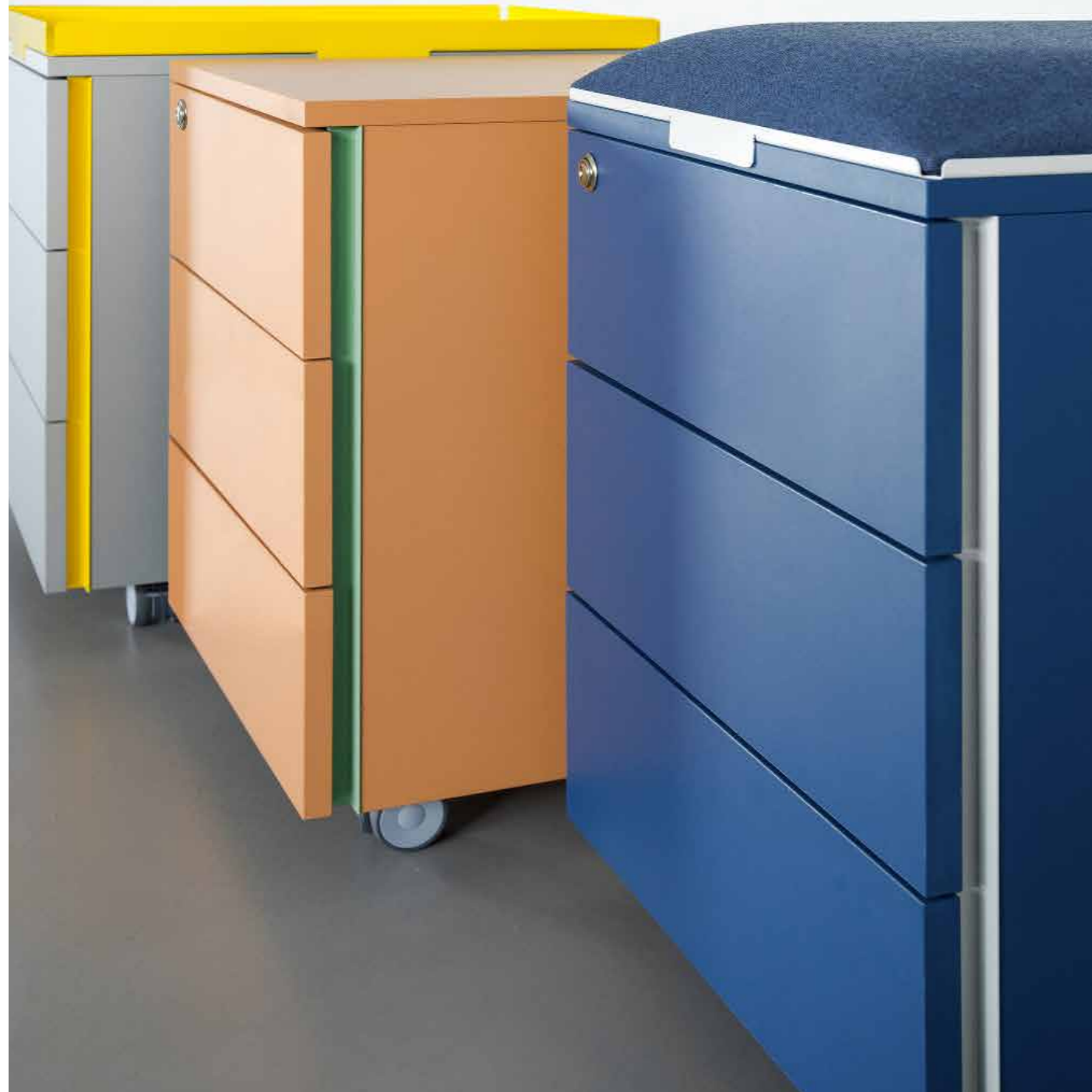

ROLLBOX 1

W 418 D 550 H 550/629

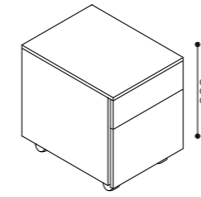

1A

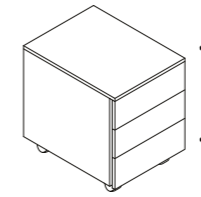

1B

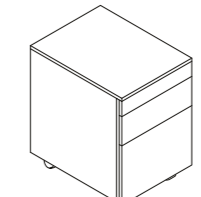

1C

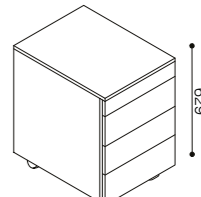

1D

ACCESORIES 1

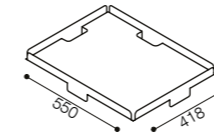

TRAY
RBT1

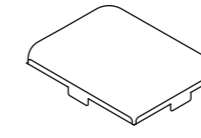

SEAT
RBS1

ROLLBOX 2

W 318 D 550 H 550/629

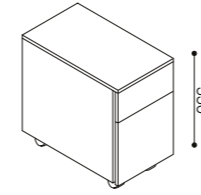

2A

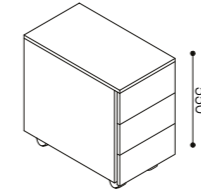

2B

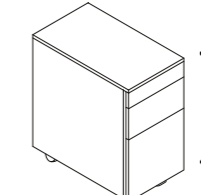

2C

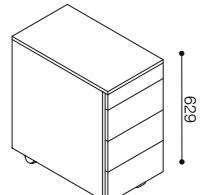

2D

ACCESORIES 2

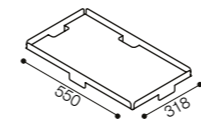

TRAY
RBT2

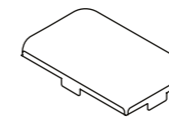

SEAT
RBS2

ROLLBOX 3

W 418 D 550 H 550/629

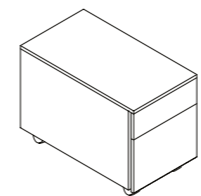

3A

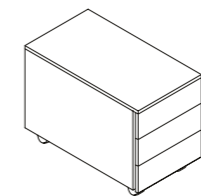

3B

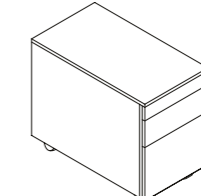

3C

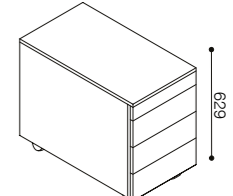

3D

ACCESORIES 3

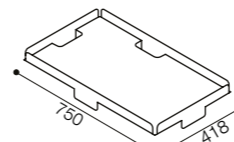

TRAY
RBT3

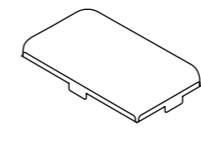

SEAT
RBS3

16

SIDEBORD



2 IN 1 PINBOARD & WHITEBOARD
by ARS

FOLDING CHAIR
by Dragos Motica

Where there's a shelf, there's stuff that can be put on it.

Complete the space by adding a **SIDEBORD** that can hold on to all the misplaced office supplies that always disappear when you need them the most. The sideboard is available in 6 different configurations and is part of the **EASYSLIDE** family.

01

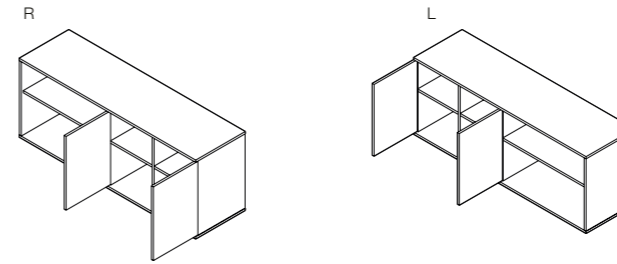
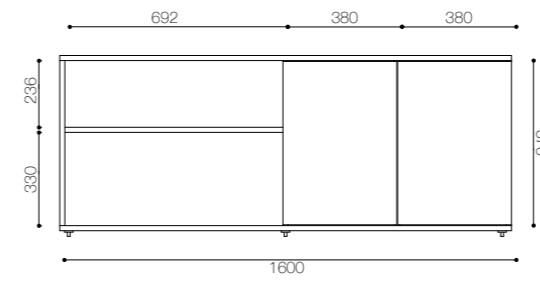

02

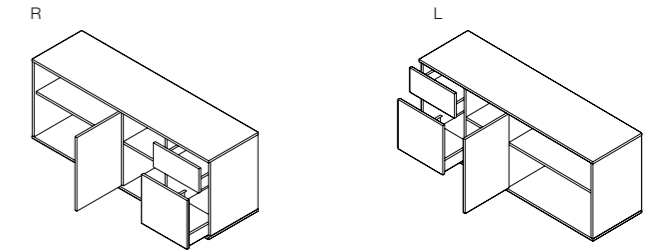
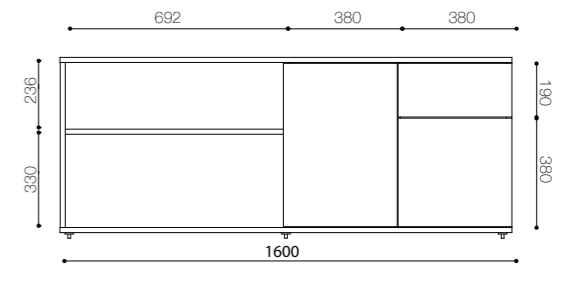

03

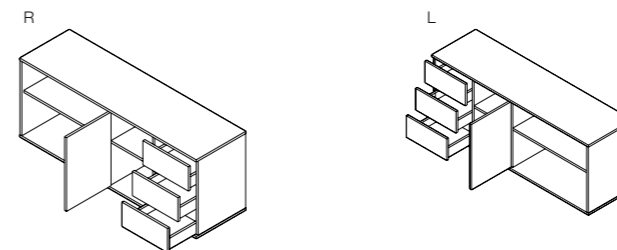
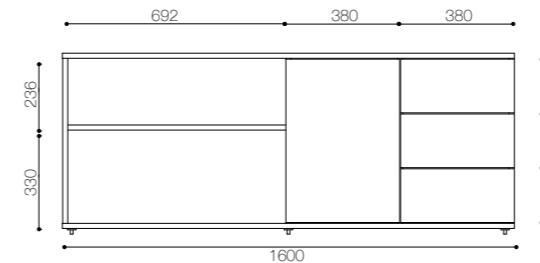

04

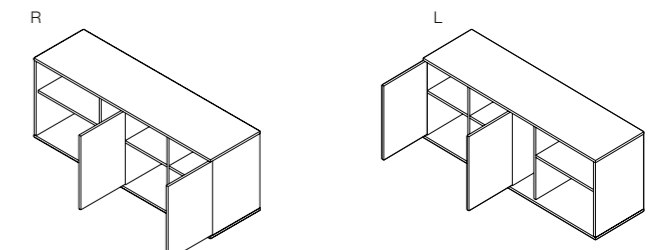
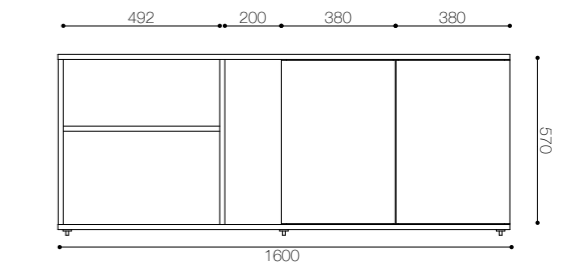

05

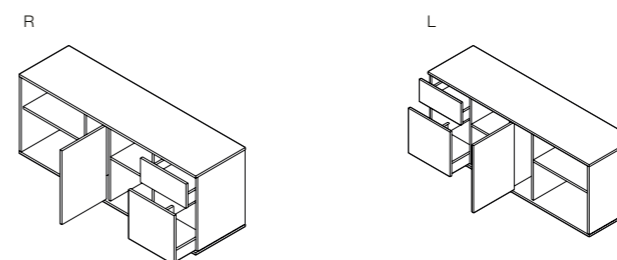
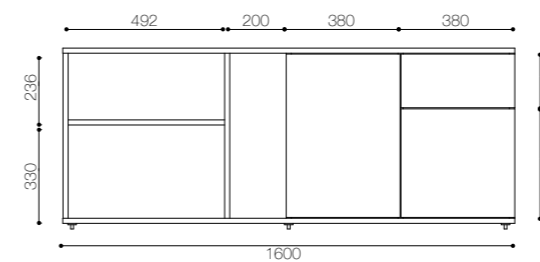

06

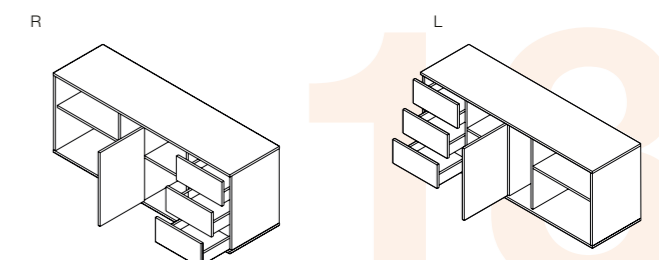
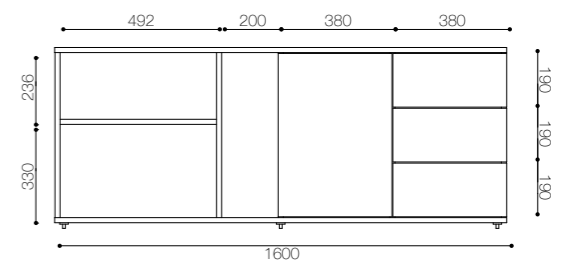

SCREEN FIXTURES



DESK SCREEN BRACKET

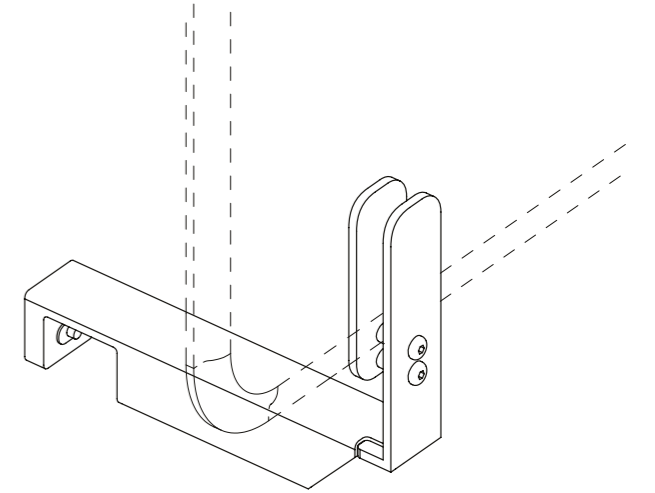
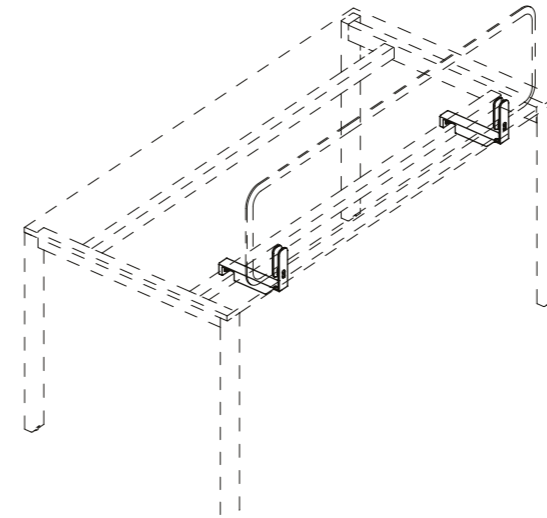

BENCH SCREEN BRACKET

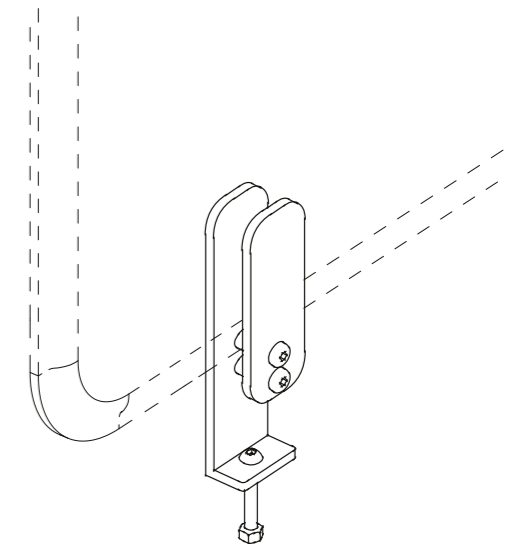
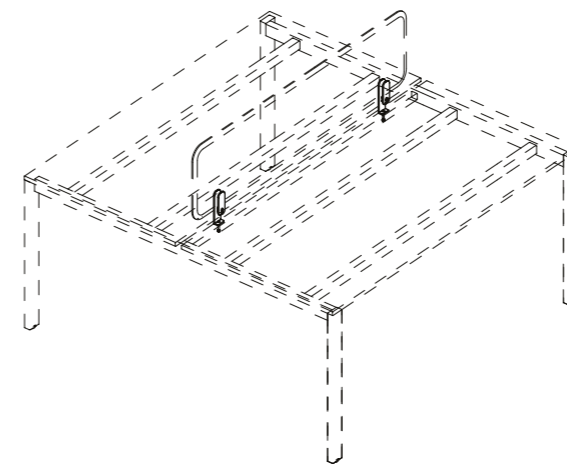

MODESTY SCREEN for desk*

*If the modesty screen is attached to a managerial desk with storage, the modesty screen is available only in 1000mm and 1200mm

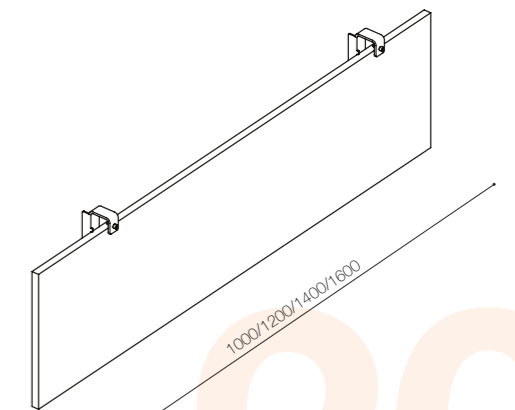
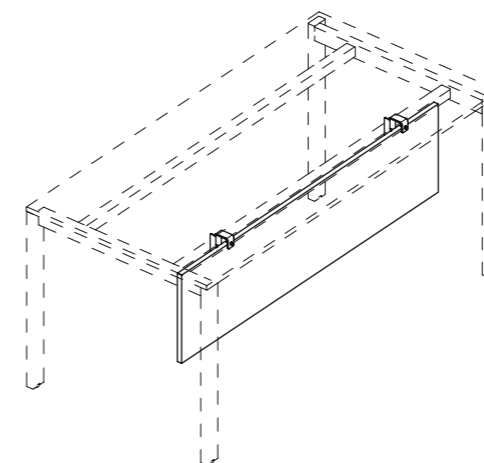

20

ACCESORIES

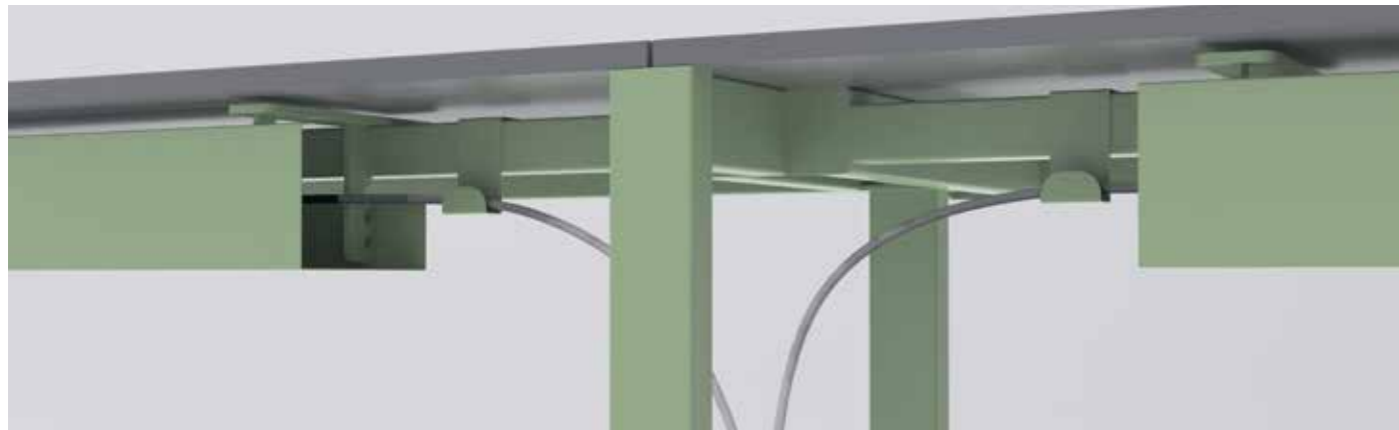

BRIDGE TRAY for desk & bench*

*The 960mm BRIDGE TRAY is compatible with 1200mm and 1400 mm desk and the 1360mm BRIDGE TRAY is compatible with the 1600mm and 1800 mm desk

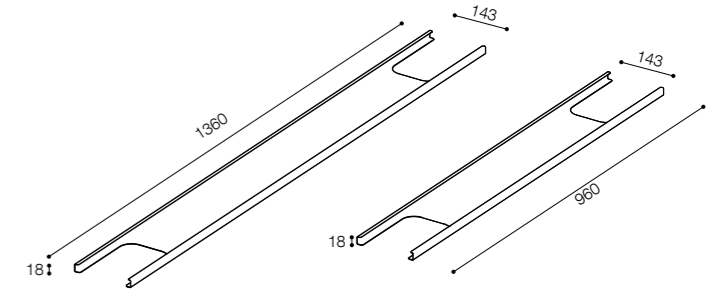
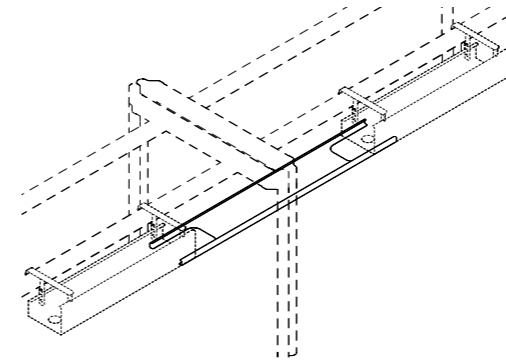

CABLE HOOK for desk & bench*

*The cable hook is compatible with every product from the Easyside collection.

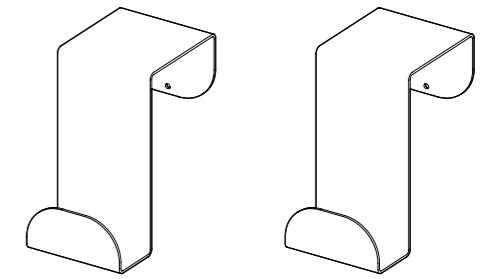
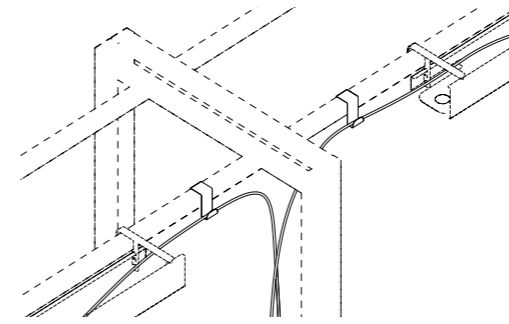

CABLE TRAY for desk & bench*

*The CABLE TRAY can be mounted in 3 different positions on the desk. It can also be placed at 3 different heights

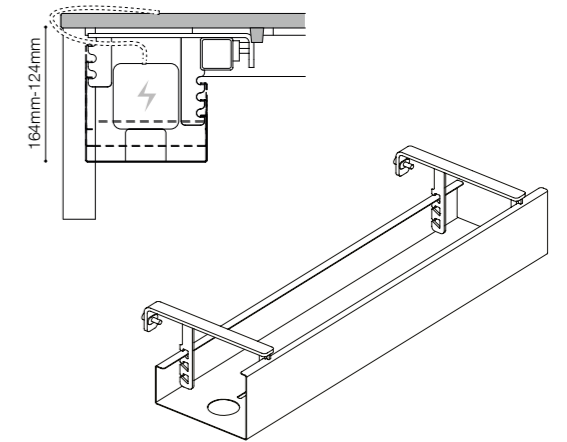
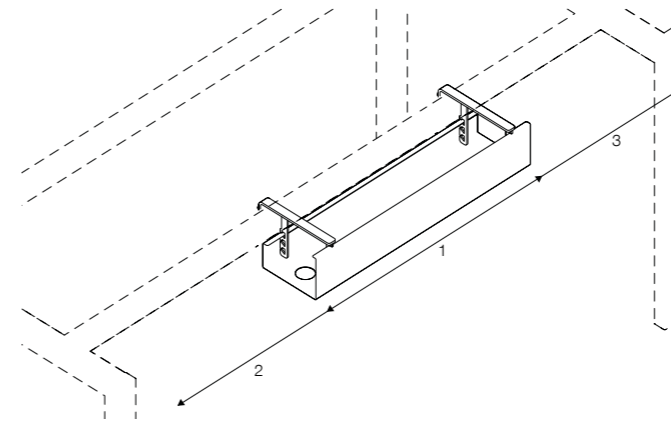

CABLE MASK for desk & bench

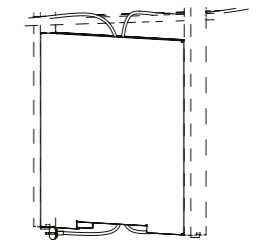
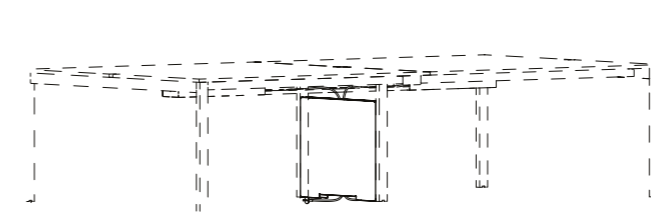

OPTIONAL

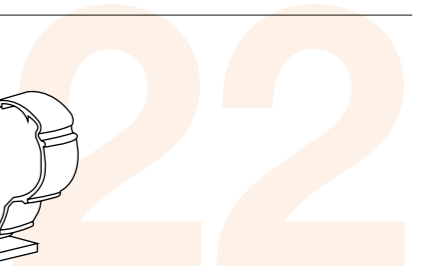
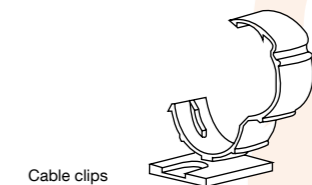
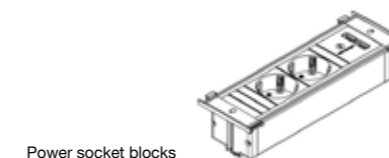
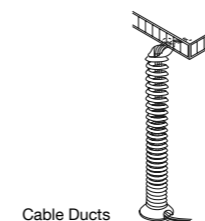



Screens and Rollbox cushion

Fabric

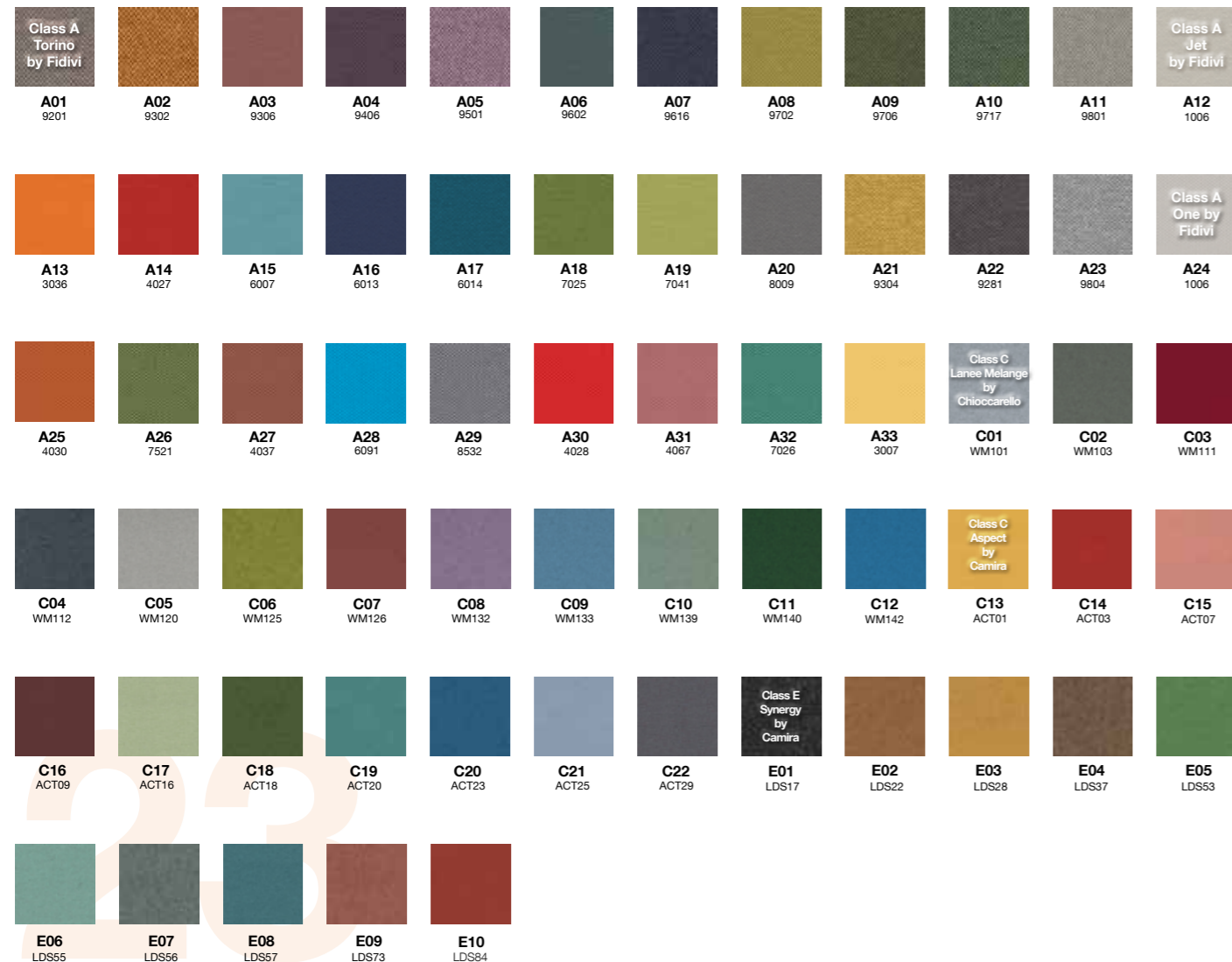

Worktop and Modesty screen

Chipboard + Melamine

Use a damp cloth to clean the entire surface. Use a microfiber cloth when dry dusting. Avoid direct sunlight and heat.



Chipboard + Veneer

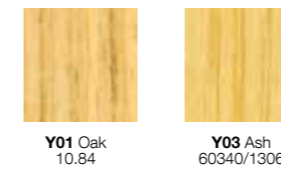

Plywood + Melamine



Plywood + Veneer

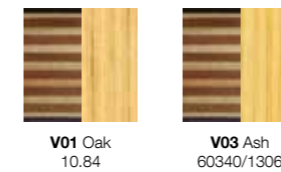

Plywood + HPL

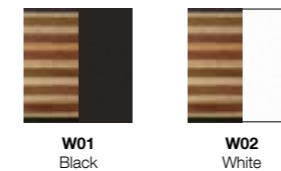

Legs and Desk Clamps

Metal

*The selected colors come with additional costs.



DESK

ROUND 35 Leg profile

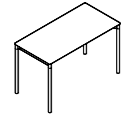

C1260
1200/600/740
24.9 kg

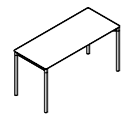

C1460
1400/600/740
27.4 kg

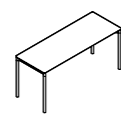

C1660
1600/600/740
29.9 kg

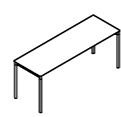

C1860
1800/600/740
32.4 kg

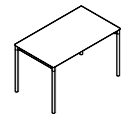

C1270
1200/700/740
27 kg

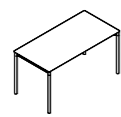

C1470
1400/700/740
29.7 kg

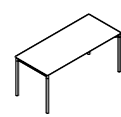

C1670
1600/700/740
32.4 kg

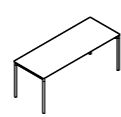

C1870
1800/700/740
35.2 kg

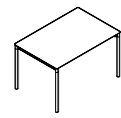

C1280
1200/800/740
29 kg

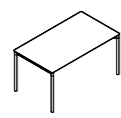

C1480
1400/800/740
32 kg

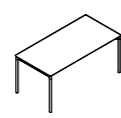

C1680
1600/800/740
35 kg

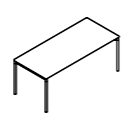

C1880
1800/800/740
38 kg

SQUARE 40 x 40 Leg profile

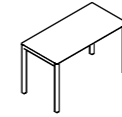

S1260
1200/600/740
25 kg

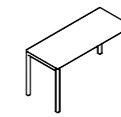

S1460
1400/600/740
27.4 kg

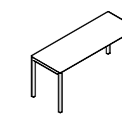

S1660
1600/600/740
29.8 kg

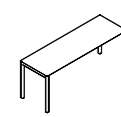

S1860
1800/600/740
32.3 kg

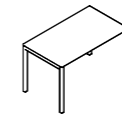

S1270
1200/700/740
26.9 kg

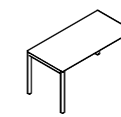

S1470
1400/700/740
29.7 kg

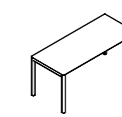

S1670
1600/700/740
32.4 kg

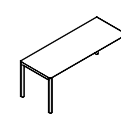

S1870
1800/700/740
35.1 kg

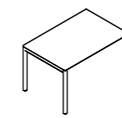

S1280
1200/800/740
29 kg

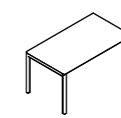

S1480
1400/800/740
32 kg

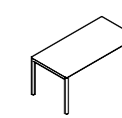

S1680
1600/800/740
35 kg

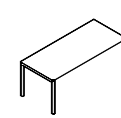

S1880
1800/800/740
38 kg

ELLIPSE 30 x 50 Leg profile

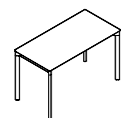

E1260
1200/600/740
25 kg

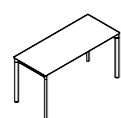

E1460
1400/600/740
26.4 kg

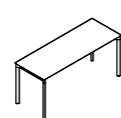

E1660
1600/600/740
29 kg

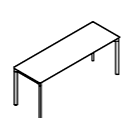

E1860
1800/600/740
31.4 kg

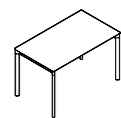

E1270
1200/700/740
26 kg

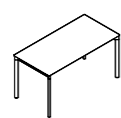

E1470
1400/700/740
28.7 kg

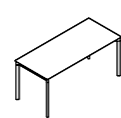

E1670
1600/700/740
31.5 kg

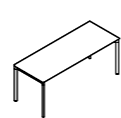

E1870
1800/700/740
34.2 kg

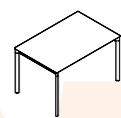

E1280
1200/800/740
28 kg

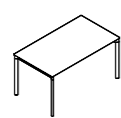

E1480
1400/800/740
31 kg

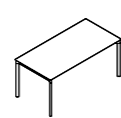

E1680
1600/800/740
34 kg

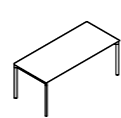

E1880
1800/800/740
37 kg

RECTANGLE 30 x 60 Leg profile

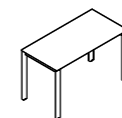

R1260
1200/600/740
25.8 kg

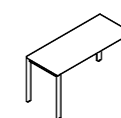

R1460
1400/600/740
28.3 kg

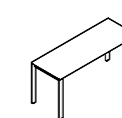

R1660
1600/600/740
30.8 kg

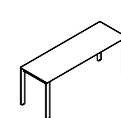

R1860
1800/600/740
33.2 kg

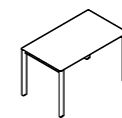

R1270
1200/700/740
27.9 kg

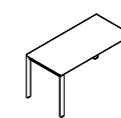

R1470
1400/700/740
30.6 kg

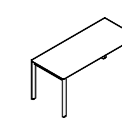

R1670
1600/700/740
33.3 kg

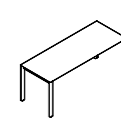

R1870
1800/700/740
36.1 kg

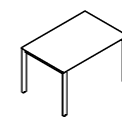

R1280
1200/800/740
29.9 kg

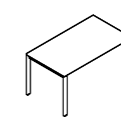

R1480
1400/800/740
32.9 kg

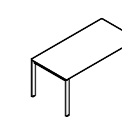

R1680
1600/800/740
35.9 kg

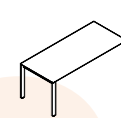

R1880
1800/800/740
38.9 kg

*Dimensions expressed in millimeters: width x depth x height

*Dimensions expressed in millimeters: width x depth x height

BENCH DESK for 2

CIRCLE 35 Leg profile

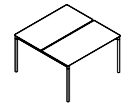

B2C1212
1200/1230/740
45 kg

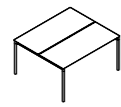

B2C1412
1400/1230/740
50 kg

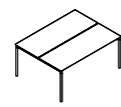

B2C1612
1600/1230/740
55.7 kg

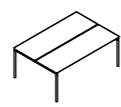

B2C1812
1800/1230/740
61 kg

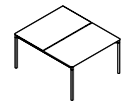

B2C1214
1200/1430/740
49.2 kg

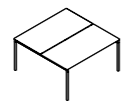

B2C1414
1400/1430/740
55.6 kg

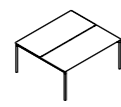

B2C1614
1600/1430/740
60.8 kg

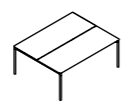

B2C1814
1800/1430/740
66.7 kg

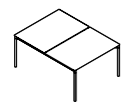

B2C1216
1200/1630/740
53.3 kg

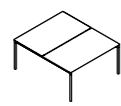

B2C1416
1400/1630/740
60.2 kg

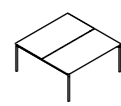

B2C1616
1600/1630/740
66 kg

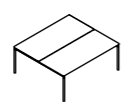

B2C1816
1800/1630/740
72.3 kg

BENCH DESK for 2

SQUARE 40 x 40 Leg profile

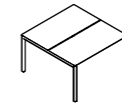

B2S1212
1200/1230/740
45 kg

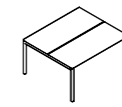

B2S1412
1400/1230/740
51 kg

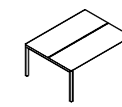

B2S1612
1600/1230/740
55.7 kg

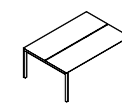

B2S1812
1800/1230/740
61.1 kg

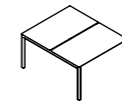

B2S1214
1200/1430/740
49.1 kg

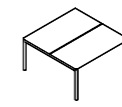

B2S1414
1400/1430/740
55.6 kg

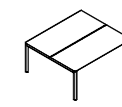

B2S1614
1600/1430/740
60.8 kg

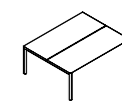

B2S1814
1800/1430/740
66.6 kg

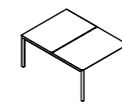

B2S1216
1200/1630/740
54.2 kg

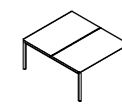

B2S1416
1400/1630/740
61.1 kg

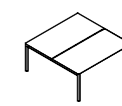

B2S1616
1600/1630/740
66.8 kg

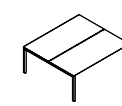

B2S1816
1800/1630/740
73.2 kg

ELLIPSE 30 x 50 Leg profile

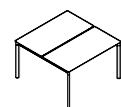

B2E1212
1200/1230/740
44.1 kg

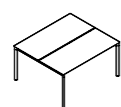

B2E1412
1400/1230/740
50 kg

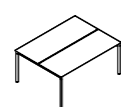

B2E1612
1600/1230/740
54.7 kg

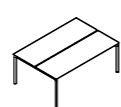

B2E1812
1800/1230/740
60 kg

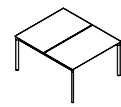

B2E1214
1200/1430/740
48.2 kg

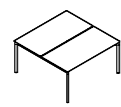

B2E1414
1400/1430/740
54.6 kg

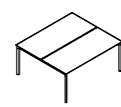

B2E1614
1600/1430/740
59.8 kg

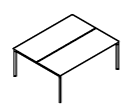

B2E1814
1800/1430/740
65.7 kg

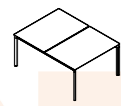

B2E1216
1200/1630/740
52.3 kg

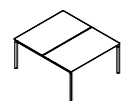

B2E1416
1400/1630/740
59.2 kg

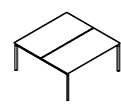

B2E1616
1600/1630/740
65.9 kg

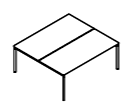

B2E1816
1800/1630/740
72.3 kg

RECTANGLE 30 x 60 Leg profile

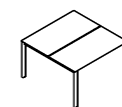

B2R1212
1200/1230/740
45.9 kg

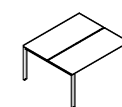

B2R1412
1400/1230/740
51.9 kg

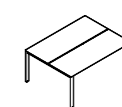

B2R1612
1600/1230/740
56.6 kg

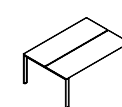

B2R1812
1800/1230/740
61.9 kg

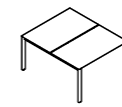

B2R1214
1200/1430/740
50 kg

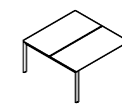

B2R1414
1400/1430/740
56.5 kg

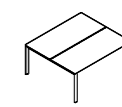

B2R1614
1600/1430/740
61.7 kg

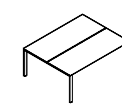

B2R1814
1800/1430/740
66.8 kg

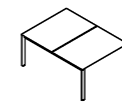

B2R1216
1200/1630/740
54.2 kg

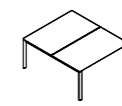

B2R1416
1400/1630/740
61.1 kg

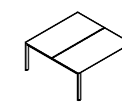

B2R1616
1600/1630/740
66.8 kg

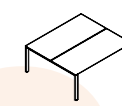

B2R1816
1800/1630/740
73.2 kg

*Dimensions expressed in millimeters: width x depth x height

*Dimensions expressed in millimeters: width x depth x height

BENCH DESK for 4

CIRCLE 35 Leg profile

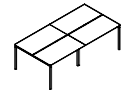

B4C2412
2403/1230/740
83.6 kg

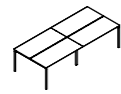

B4C2812
2803/1230/740
96.7 kg

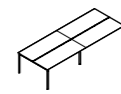

B4C3212
3203/1230/740
107.2 kg

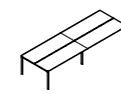

B4C3612
3603/1230/740
118.9 kg

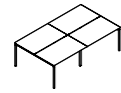

B4C2414
2403/1430/740
90.8 kg

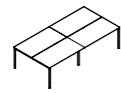

B4C2814
2803/1430/740
104.8 kg

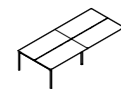

B4C3214
3203/1430/740
116.3 kg

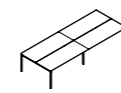

B4C3614
3603/1430/740
129.1 kg

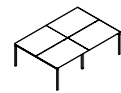

B4C2416
2403/1630/740
97.9 kg

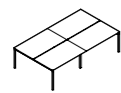

B4C2816
2803/1630/740
112.9 kg

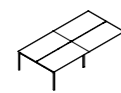

B4C3216
3203/1630/740
125.5 kg

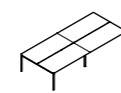

B4C3616
3603/1630/740
139.3 kg

BENCH DESK for 4

SQUARE 40 x 40 Leg profile

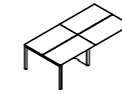

B4S2412
2403/1230/740
82.8 kg

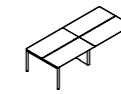

B4S2812
2803/1230/740
95.8 kg

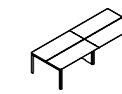

B4S3212
3203/1230/740
106.3 kg

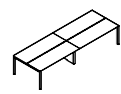

B4S3612
3603/1230/740
118.2 kg

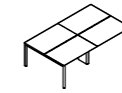

B4S2414
2403/1430/740
90 kg

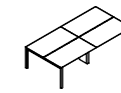

B4S2814
2803/1430/740
103.9 kg

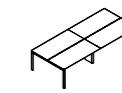

B4S3214
3203/1430/740
115.5 kg

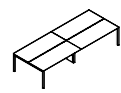

B4S3614
3603/1430/740
128.2 kg

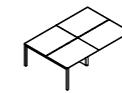

B4S2416
2403/1630/740
99.3 kg

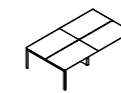

B4S2816
2803/1630/740
114.3 kg

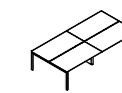

B4S3216
3203/1630/740
126.8 kg

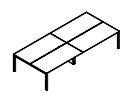

B4S3616
3603/1630/740
140.6 kg

ELLIPSE 30 x 50 Leg profile

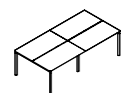

B4E2412
2403/1230/740
82.2 kg

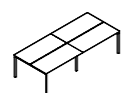

B4E2812
2803/1230/740
95.1 kg

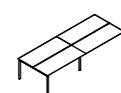

B4E3212
3203/1230/740
105.7 kg

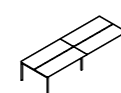

B4E3612
3603/1230/740
117.4 kg

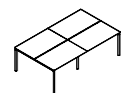

B4E2414
2403/1430/740
89.3 kg

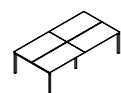

B4E2814
2803/1430/740
103.3 kg

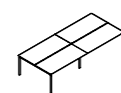

B4E3214
3203/1430/740
114.8 kg

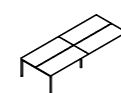

B4E3614
3603/1430/740
117.4 kg

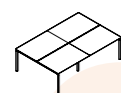

B4E2416
2403/1630/740
96.4 kg

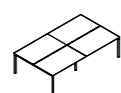

B4E2816
2803/1630/740
111.4 kg

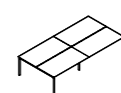

B4E3216
3203/1630/740
124.1 kg

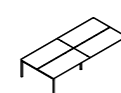

B4E3616
3603/1630/740
137.8 kg

RECTANGLE 30 x 60 Leg profile

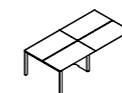

B4R2412
2403/1230/740
85 kg

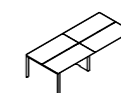

B2E2812
2803/1230/740
97.9 kg

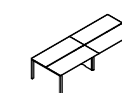

B4R3212
3203/1230/740
108.5 kg

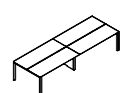

B4R3612
3603/1230/740
120.2 kg

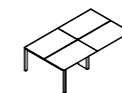

B4R2414
2403/1430/740
92.1 kg

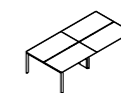

B4R2814
2803/1430/740
106.1 kg

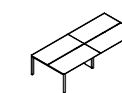

B4R3214
3203/1430/740
117.6 kg

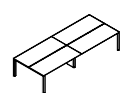

B4R3614
3603/1430/740
130.4 kg

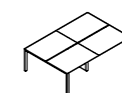

B4R2416
2403/1630/740
99.3 kg

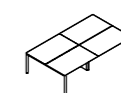

B4R2816
2803/1630/740
114.3 kg

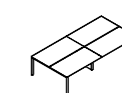

B4R3216
3203/1630/740
126.8 kg

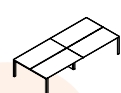

B4R3616
3603/1630/740
140.6 kg

*Dimensions expressed in millimeters: width x depth x height

*Dimensions expressed in millimeters: width x depth x height

BENCH DESK for 6

CIRCLE 35 Leg profile

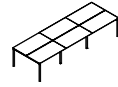

B6C3612
3606/1230/740
122.2 kg



B6C4212
4206/1230/740
142.3 kg

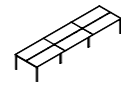

B6C4812
4806/1230/740
158.6 kg

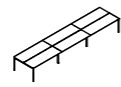

B6C5412
5406/1230/740
176.8 kg

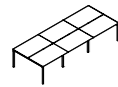

B6C3614
3606/1430/740
132.4 kg



B6C4214
4206/1430/740
153.9 kg

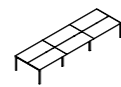

B6C4814
4806/1430/740
171.8 kg

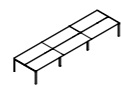

B6C5414
5406/1430/740
177.9 kg



B6C3616
3606/1630/740
142.6 kg

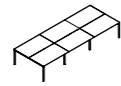

B6C4216
4206/1630/740
165.6 kg

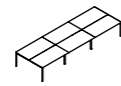

B6R4816
4806/1630/740
185 kg

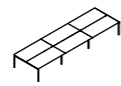

B6C5416
5406/1630/740
206.2 kg

BENCH DESK for 6

SQUARE 40 x 40 Leg profile



B6S3612
3606/1230/740
120.6 kg

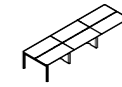

B6S4212
4206/1230/740
140.6 kg

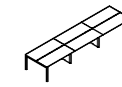

B6S4812
4806/1230/740
157.1 kg

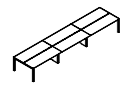

B6S5412
5406/1230/740
175.1 kg

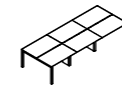

B6S3614
3606/1430/740
130.8 kg

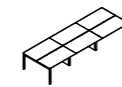

B6S4214
4206/1430/740
125.3 kg

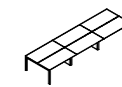

B6S4814
4806/1430/740
170.2 kg

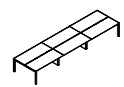

B6S5414
5406/1430/740
176.2 kg

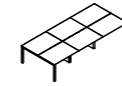

B6S3616
3606/1630/740
140.9 kg

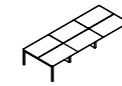

B6S4216
4206/1630/740
164.1 kg

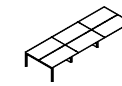

B6S4816
4806/1630/740
183.4 kg

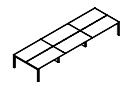

B6S5416
5406/1630/740
204.6 kg

ELLIPSE 30 x 50 Leg profile

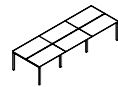

B6E3612
3606/1230/740
120.3 kg

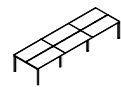

B6E4212
4206/1230/740
140.3 kg

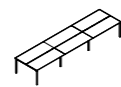

B6E4812
4806/1230/740
156.6 kg

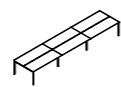

B6E5412
5406/1230/740
174.8 kg

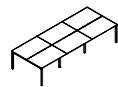

B6E3614
3606/1430/740
130.4 kg

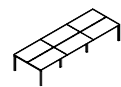

B6E4214
4206/1430/740
161.1 kg

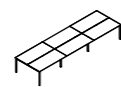

B6E4814
4806/1430/740
169.8 kg

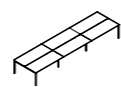

B6E5414
5406/1430/740
175.9 kg

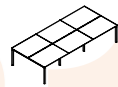

B6E3616
3606/1630/740
140.6 kg

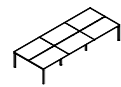

B6E4216
4206/1630/740
163.6 kg

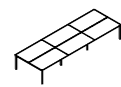

B6E4816
4806/1630/740
183.1 kg

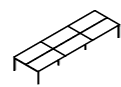

B6E5416
5406/1630/740
204.2 kg

RECTANGLE 30 x 60 Leg profile



B6R3612
3606/1230/740
124.1 kg

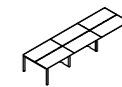

B6R4212
4206/1230/740
144.1 kg

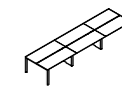

B6R4812
4806/1230/740
160.4 kg

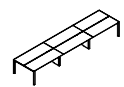

B6R5412
5406/1230/740
176.6 kg

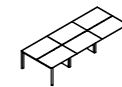

B6R3614
3606/1430/740
134.2 kg

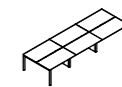

B6R4214
4206/1430/740
155.7 kg

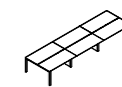

B6R4814
4806/1430/740
173.6 kg

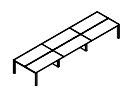

B6R5414
5406/1430/740
179.7 kg

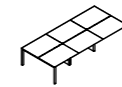

B6R3616
3606/1630/740
144.3 kg

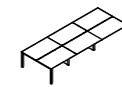

B6R4216
4206/1630/740
167.4 kg

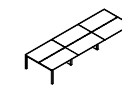

B6R4816
4806/1630/740
186.8 kg

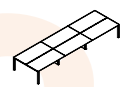

B6R5416
5406/1630/740
208.1 kg









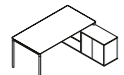
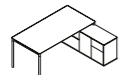
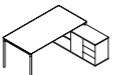
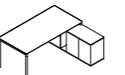
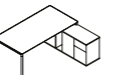
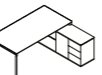
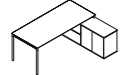
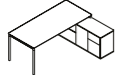
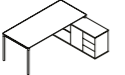

*Dimensions expressed in millimeters: width x depth x height

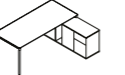
*Dimensions expressed in millimeters: width x depth x height

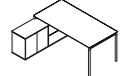
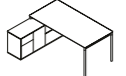
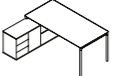
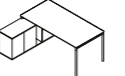
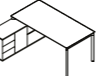
MANAGERIAL DESK

CIRCLE 35 Leg profile



 MC1601R 1600/1600/740 132.2 kg	 MC1602R 1600/1600/740 133.6 kg	 MC1603R 1600/1600/740 133.6 kg	 MC1604R 1600/1600/740 139.6 kg	 MC1605R 1600/1600/740 140.1 kg	 MC1606R 1600/1600/740 140.1 kg
 MC1801R 1800/1600/740 135.2 kg	 MC1802R 1800/1600/740 136.6 kg	 MC1803R 1800/1600/740 130.8 kg	 MC1804R 1800/1600/740 142.6 kg	 MC1805R 1800/1600/740 143.1 kg	 MC1806R 1800/1600/740 143.1 kg
 MC1601L 1600/1600/740 135.2 kg	 MC1602L 1600/1600/740 136.6 kg	 MC1603L 1600/1600/740 136.6 kg	 MC1604L 1600/1600/740 139.6 kg	 MC1605L 1600/1600/740 140.1 kg	 MC1606L 1600/1600/740 140.1 kg
 MC1801L 1800/1600/740 135.2 kg	 MC1802L 1800/1600/740 136.6 kg	 MC1803L 1800/1600/740 136.6 kg	 MC1804L 1800/1600/740 142.6 kg	 MC1805L 1800/1600/740 143.1 kg	 MC1806L 1800/1600/740 143.1 kg

ELLIPSE 30 x 50 Leg profile



 ME1601R 1600/1600/740 131.2 kg	 ME1602R 1600/1600/740 132.6 kg	 ME1603R 1600/1600/740 132.6 kg	 ME1604R 1600/1600/740 138.6 kg	 ME1605R 1600/1600/740 139.1 kg	 ME1606R 1600/1600/740 139.1 kg
 ME1801R 1800/1600/740 134.2 kg	 ME1802R 1800/1600/740 135.6 kg	 ME1803R 1800/1600/740 135.6 kg	 ME1804R 1800/1600/740 141.6 kg	 ME1805R 1800/1600/740 137.2 kg	 ME1806R 1800/1600/740 142.1 kg
 ME1601L 1600/1600/740 131.2 kg	 ME1602L 1600/1600/740 132.6 kg	 ME1603L 1600/1600/740 132.6 kg	 ME1604L 1600/1600/740 138.6 kg	 ME1605L 1600/1600/740 139.1 kg	 ME1606L 1600/1600/740 139.1 kg
 ME1801L 1800/1600/740 134.2 kg	 ME1802L 1800/1600/740 135.6 kg	 ME1803L 1800/1600/740 135.6 kg	 ME1804L 1800/1600/740 141.6 kg	 ME1805L 1800/1600/740 137.2 kg	 ME1806L 1800/1600/740 142.1 kg

*Dimensions expressed in millimeters: width x depth x height

MANAGERIAL DESK

SQUARE 40 x 40 Leg profile



 MS1601R 1600/1600/740 132.2 kg	 MS1602R 1600/1600/740 133.6 kg	 MS1603R 1600/1600/740 133.6 kg	 MS1604R 1600/1600/740 139.6 kg	 MS1605R 1600/1600/740 140.1 kg	 MS1606R 1600/1600/740 140.1 kg
 MS1801R 1800/1600/740 135.2 kg	 MS1802R 1800/1600/740 136.6 kg	 MS1803R 1800/1600/740 136.6 kg	 MS1804R 1800/1600/740 142.6 kg	 MS1805R 1800/1600/740 143.1 kg	 MS1806R 1800/1600/740 143.1 kg
 MS1601L 1600/1600/740 132.2 kg	 MS1602L 1600/1600/740 133.6 kg	 MS1603L 1600/1600/740 133.6 kg	 MS1604L 1600/1600/740 139.6 kg	 MS1605L 1600/1600/740 140.1 kg	 MS1606L 1600/1600/740 140.1 kg
 MS1801L 1800/1600/740 135.2 kg	 MS1802L 1800/1600/740 136.6 kg	 MS1803L 1800/1600/740 136.6 kg	 MS1804L 1800/1600/740 142.6 kg	 MS1805L 1800/1600/740 143.1 kg	 MS1806L 1800/1600/740 143.1 kg

RECTANGLE 30 x 60 Leg profile



 MR1601R 1600/1600/740 133.1 kg	 MR1602R 1600/1600/740 134.5 kg	 MR1603R 1600/1600/740 134.5 kg	 MR1604R 1600/1600/740 140.5 kg	 MR1605R 1600/1600/740 141 kg	 MR1606R 1600/1600/740 141 kg
 MR1801R 1800/1600/740 136.1 kg	 MR1802R 1800/1600/740 137.5 kg	 MR1803R 1800/1600/740 137.5 kg	 MR1804R 1800/1600/740 143.5 kg	 MR1805R 1800/1600/740 144 kg	 MR1806R 1800/1600/740 144 kg
 MR1601L 1600/1600/740 133.1 kg	 MR1602L 1600/1600/740 134.5 kg	 MR1603L 1600/1600/740 134.5 kg	 MR1604L 1600/1600/740 127.8 kg	 MR1605L 1600/1600/740 141 kg	 MR1606L 1600/1600/740 141 kg
 MR1801L 1800/1600/740 136.1 kg	 MR1802L 1800/1600/740 137.5 kg	 MR1803L 1800/1600/740 137.5 kg	 MR1804L 1800/1600/740 143.5 kg	 MR1805L 1800/1600/740 144 kg	 MR1806L 1800/1600/740 144 kg

*Dimensions expressed in millimeters: width x depth x height

ISLAND



DESK Module extension*

*desk extensions have rectangular legs



BENCH Module extension*

*desk extensions have rectangular legs

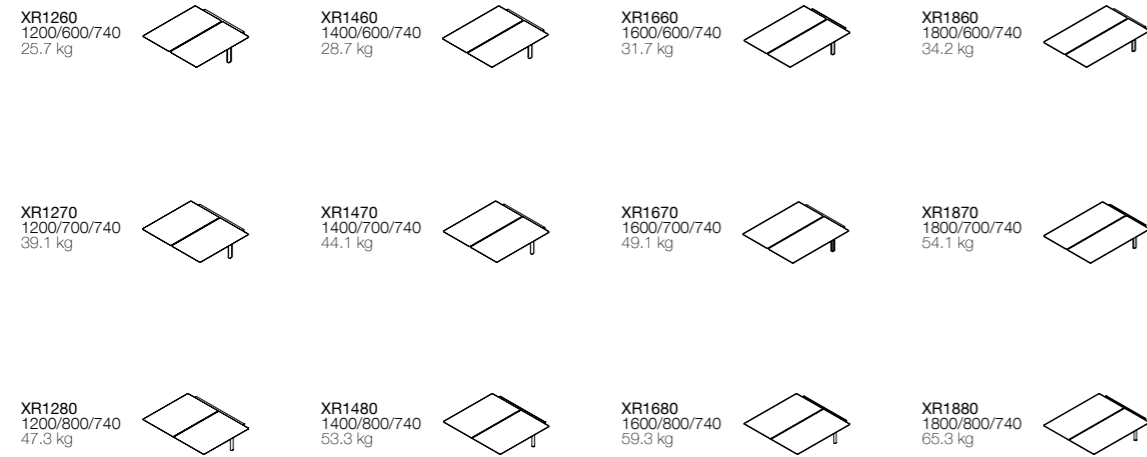

CONSOLE Module extension

*for island

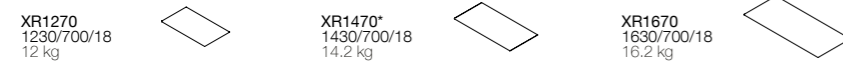

L Module extension

*L module is available in all leg profiles



WORKTOP Connector

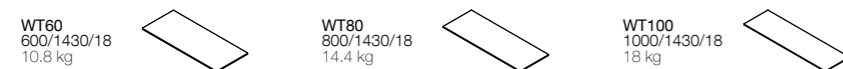

CABLE MASK for bench

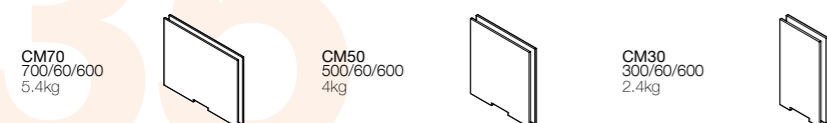

*Dimensions expressed in millimeters: width x depth x height

CABINET CONNECTOR for island

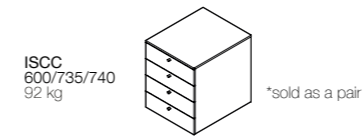

ROLLBOX

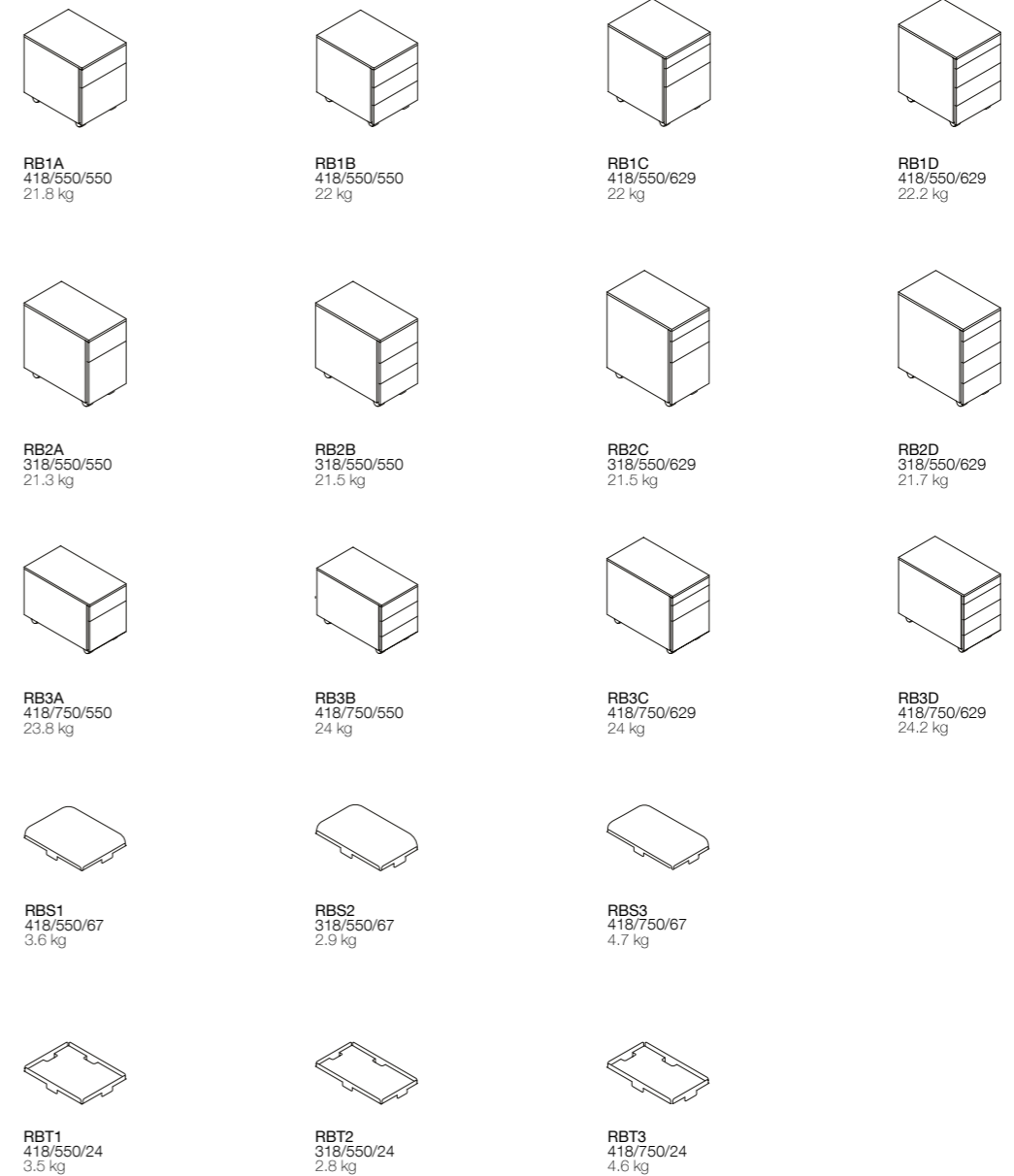

*Dimensions expressed in millimeters: width x depth x height

SIDEBOARDS

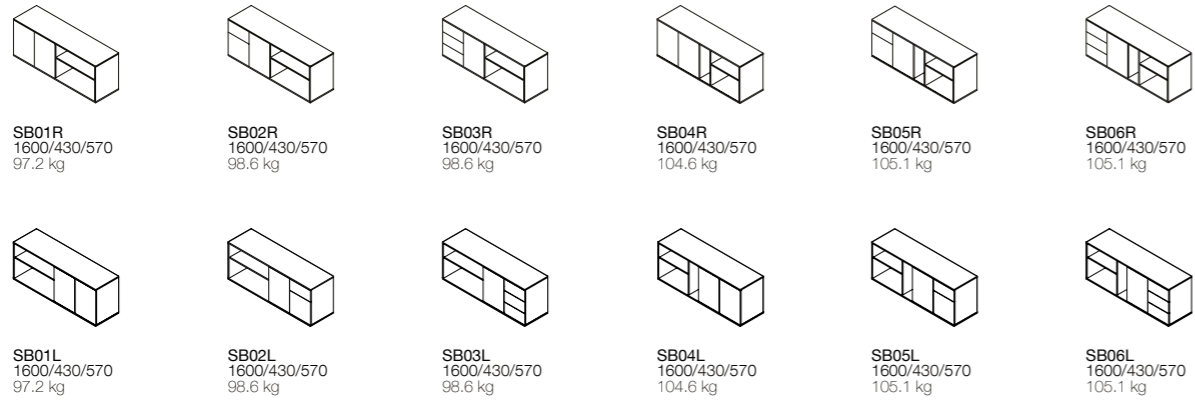

CABLE ACCESORIES for desk & bench

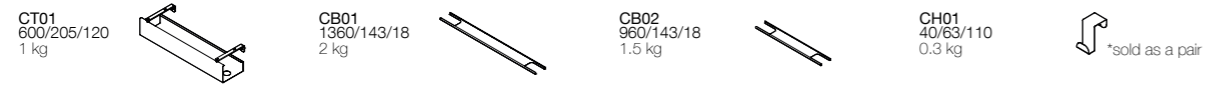

OPTIONAL

*can be customized



MODESTY PANELS for desk & bench

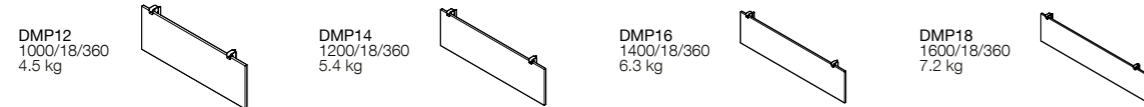

SCREEN FIXTURES for desk & bench

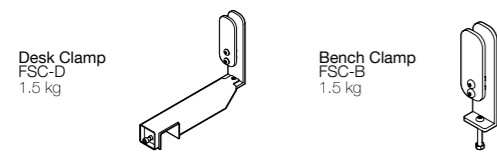

CONNECT COLLECTION SCREENS

CHIPBOARD

FRONT SCREEN

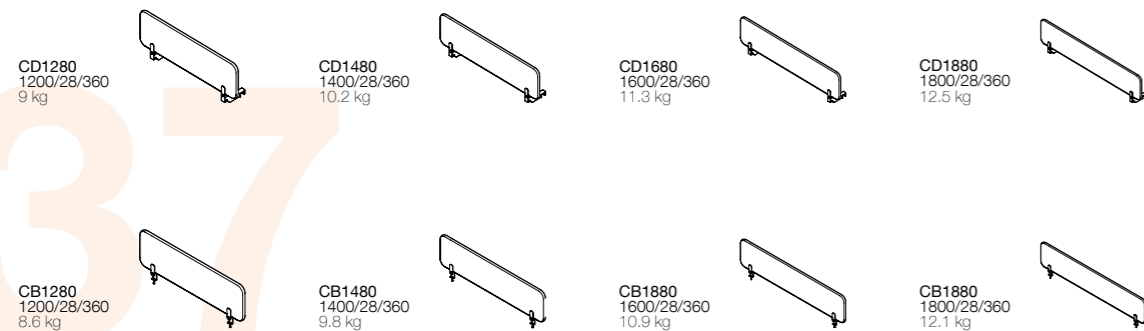

SIDE SCREEN



ACOUSTIC PET FELT

FRONT SCREEN

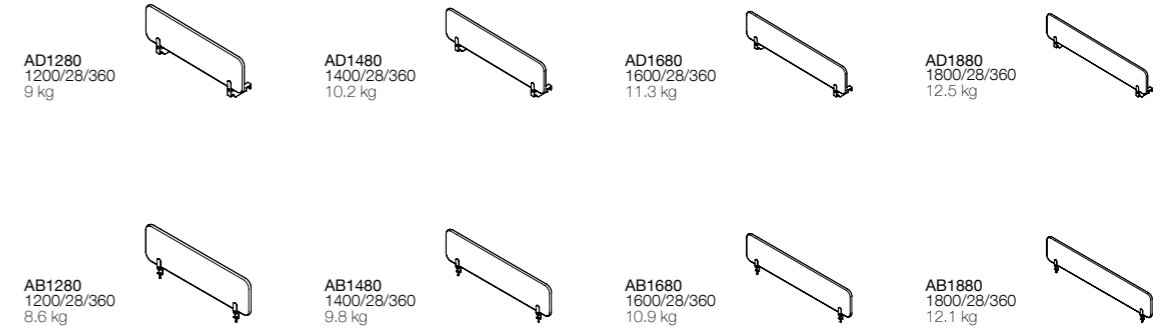

SIDE SCREEN

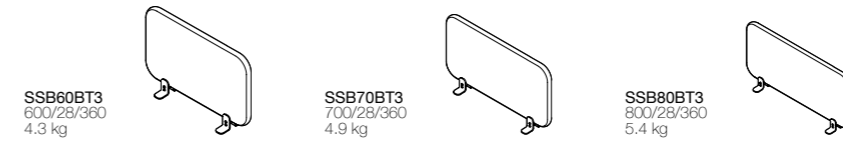

THERMOFORMED

FRONT SCREEN

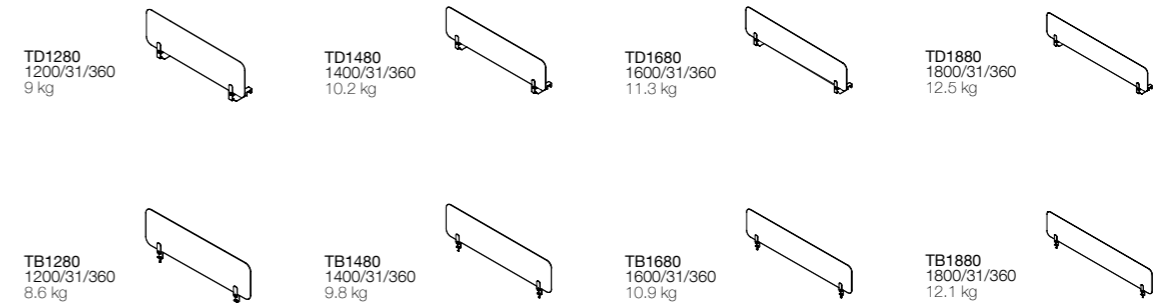

SIDE SCREEN

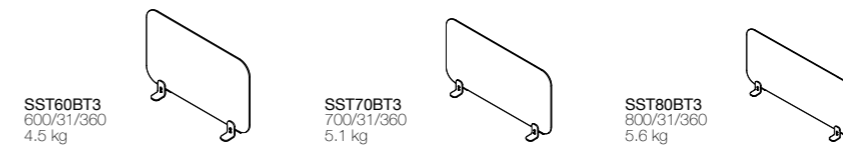

*Dimensions expressed in millimeters: width x depth x height

Order form model*

* For color options, see pages 23 & 24

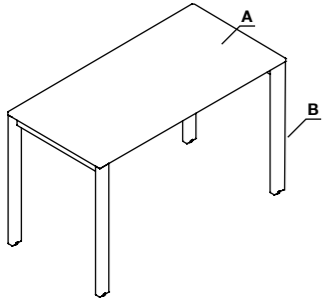
Desk, Bench, Island									
	<table border="1"> <tr> <td>Index Code</td> <td>R1260</td> </tr> <tr> <td>Worktop color (A)</td> <td>X03</td> </tr> <tr> <td>Leg color (B)</td> <td>B02</td> </tr> <tr> <td>Code format</td> <td>R1260 X03 B02</td> </tr> </table>	Index Code	R1260	Worktop color (A)	X03	Leg color (B)	B02	Code format	R1260 X03 B02
Index Code	R1260								
Worktop color (A)	X03								
Leg color (B)	B02								
Code format	R1260 X03 B02								

Category A - can have the following finishes: X01 - W02

Category B - can have the following finishes: B01 - B08

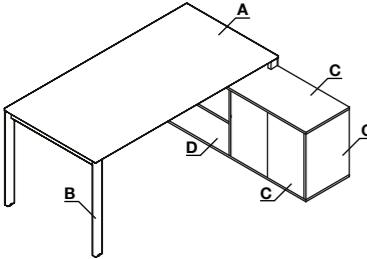
Managerial													
	<table border="1"> <tr> <td>Index Code</td> <td>MC1601R</td> </tr> <tr> <td>Worktop color (A)</td> <td>X04</td> </tr> <tr> <td>Body color (C)</td> <td>X04</td> </tr> <tr> <td>Cabinet color (D)</td> <td>X07</td> </tr> <tr> <td>Leg color (B)</td> <td>B05</td> </tr> <tr> <td>Code format</td> <td>MC1601R X04 B05 X04 X07</td> </tr> </table>	Index Code	MC1601R	Worktop color (A)	X04	Body color (C)	X04	Cabinet color (D)	X07	Leg color (B)	B05	Code format	MC1601R X04 B05 X04 X07
Index Code	MC1601R												
Worktop color (A)	X04												
Body color (C)	X04												
Cabinet color (D)	X07												
Leg color (B)	B05												
Code format	MC1601R X04 B05 X04 X07												

Categories C and D - can have the following finishes: X01 - Y03

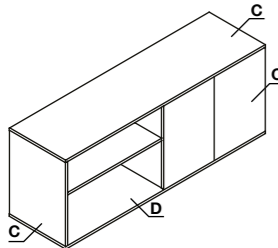
Sideboard									
	<table border="1"> <tr> <td>Index Code</td> <td>SB-01</td> </tr> <tr> <td>Body color (C)</td> <td>X02</td> </tr> <tr> <td>Cabinet color (D)</td> <td>X02</td> </tr> <tr> <td>Code format</td> <td>SB01 X02 X02</td> </tr> </table>	Index Code	SB-01	Body color (C)	X02	Cabinet color (D)	X02	Code format	SB01 X02 X02
Index Code	SB-01								
Body color (C)	X02								
Cabinet color (D)	X02								
Code format	SB01 X02 X02								

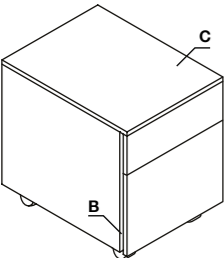
Rollbox									
	<table border="1"> <tr> <td>Index Code</td> <td>RB1A</td> </tr> <tr> <td>Body color (C)</td> <td>X04</td> </tr> <tr> <td>Drawer interior edge (B)</td> <td>B01</td> </tr> <tr> <td>Code format</td> <td>RB1A X04 B01</td> </tr> </table>	Index Code	RB1A	Body color (C)	X04	Drawer interior edge (B)	B01	Code format	RB1A X04 B01
Index Code	RB1A								
Body color (C)	X04								
Drawer interior edge (B)	B01								
Code format	RB1A X04 B01								

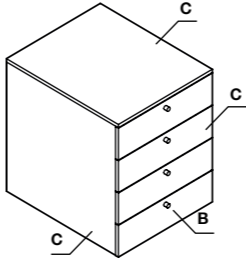
Cabinet Connector									
	<table border="1"> <tr> <td>Index Code</td> <td>ISCC</td> </tr> <tr> <td>Body color (C)</td> <td>X04</td> </tr> <tr> <td>Handle (B)</td> <td>B01</td> </tr> <tr> <td>Code format</td> <td>ISCC X04 B01</td> </tr> </table>	Index Code	ISCC	Body color (C)	X04	Handle (B)	B01	Code format	ISCC X04 B01
Index Code	ISCC								
Body color (C)	X04								
Handle (B)	B01								
Code format	ISCC X04 B01								

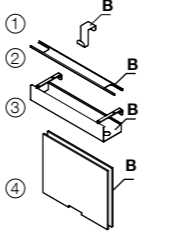
Cable accessories							
	<table border="1"> <tr> <td>Index Code</td> <td>1) CH01; 2) CB01; 3) CT01; 4) CM70</td> </tr> <tr> <td>Metal color (B)</td> <td>B07</td> </tr> <tr> <td>Code format</td> <td>1) CH01 B07; 2) CB01 B07; 3) CT01 B07; 4) CM70 B07</td> </tr> </table>	Index Code	1) CH01; 2) CB01; 3) CT01; 4) CM70	Metal color (B)	B07	Code format	1) CH01 B07; 2) CB01 B07; 3) CT01 B07; 4) CM70 B07
Index Code	1) CH01; 2) CB01; 3) CT01; 4) CM70						
Metal color (B)	B07						
Code format	1) CH01 B07; 2) CB01 B07; 3) CT01 B07; 4) CM70 B07						

*When purchasing a desk set, all metal parts will have the same color

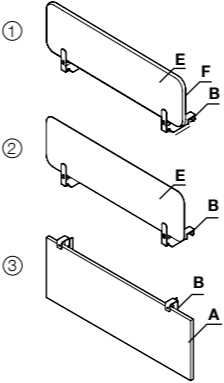
Screens*													
	<table border="1"> <tr> <td>Index Code</td> <td>1) AD1280; 2) TD1280; 3) DMP12</td> </tr> <tr> <td>Face color (E)</td> <td>A20</td> </tr> <tr> <td>Edge color (F)</td> <td>A21</td> </tr> <tr> <td>Body color (A)</td> <td>X04</td> </tr> <tr> <td>Fixtures color (B)</td> <td>B06</td> </tr> <tr> <td>Code format</td> <td>1) AD1280 A20 A21 B06; 2) TD1280 A20 B06; 3) DMP12 X04 B06</td> </tr> </table>	Index Code	1) AD1280; 2) TD1280; 3) DMP12	Face color (E)	A20	Edge color (F)	A21	Body color (A)	X04	Fixtures color (B)	B06	Code format	1) AD1280 A20 A21 B06; 2) TD1280 A20 B06; 3) DMP12 X04 B06
Index Code	1) AD1280; 2) TD1280; 3) DMP12												
Face color (E)	A20												
Edge color (F)	A21												
Body color (A)	X04												
Fixtures color (B)	B06												
Code format	1) AD1280 A20 A21 B06; 2) TD1280 A20 B06; 3) DMP12 X04 B06												

Categories E, F and G - can have the following finishes: A01 - E10

Category A - can have the following finishes: X01 - W02

* The face fabric and the edge fabric must be from the same collection.

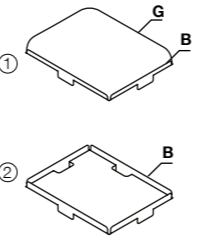
Rollbox accesories									
	<table border="1"> <tr> <td>Index Code</td> <td>1) RBS1; 2) RBT1</td> </tr> <tr> <td>Cushion (G)</td> <td>A20</td> </tr> <tr> <td>Tray/ Cushion structure (B)</td> <td>B01</td> </tr> <tr> <td>Code format</td> <td>RBS1 A20 B01; RBT1 B01</td> </tr> </table>	Index Code	1) RBS1; 2) RBT1	Cushion (G)	A20	Tray/ Cushion structure (B)	B01	Code format	RBS1 A20 B01; RBT1 B01
Index Code	1) RBS1; 2) RBT1								
Cushion (G)	A20								
Tray/ Cushion structure (B)	B01								
Code format	RBS1 A20 B01; RBT1 B01								



ASKIA

Eliade Tower,
Mircea Eliade No.18
RO-Bucharest, 012015

T +40 212 121 381
contact@askiafurniture.ro

www.askiafurniture.ro